









LISTWY WYKOŃCZENIOWE I ELEMENTY ARANŻACJI WNĘTRZ



LISTWY WYKOŃCZENIOWE I ELEMENTY ARANŻACJI WNĘTRZ
FINISHING PROFILES AND ELEMENTS OF INTERIOR DESIGN
LISTWY WYKOŃCZENIOWE I ELEMENTY ARANŻACJI WNĘTRZ
FINISHING PROFILES AND ELEMENTS OF INTERIOR DESIGN LISTWY



SPIS TREŚCI

TABLE OF CONTENTS | INHALTSÜBERSICHT | ОГЛАВЛЕНИЕ

	ALUMINIOWE LISTWY WYKOŃCZENIOWE ALUMINIUM FINISHING STRIPS DIE ALUMINIUMLEISTEN АЛЮМИНИЕВЫЕ ОТДЕЛОЧНЫЕ ПРОФИЛИ	8
	ALUMINIOWE LISTWY COKOŁOWE ALUMINIUM SKIRTING BOARD ALUMINIUM SOCKELLEISTEN АЛЮМИНИЕВЫЕ ЦОКОЛЬНЫЕ ПРОФИЛЯ	30
	ALUMINIOWE I MOSIĘŻNE LISTWY DO GLAZURY I TERAKOTY ALUMINIUM AND BRASS PROFILES FOR TILES FLIESENPROFILE AUS ALUMINIUM UND MESSING АЛЮМИНИЕВЫЕ И ЛАТУННЫЕ ПРОФИЛИ ДЛЯ КАФЕЛЬНОЙ ПЛИТКИ	34
	LISTWY WYKOŃCZENIOWE GIĘTE BENDABLE FINISHING STRIPS BIEGELEISTEN ОТДЕЛОЧНЫЕ ГНУТЫЕ ПРОФИЛИ	42
	LISTWA PRZYPODŁOGOWA PVC PVC SKIRTING BOARD SOCKELKUNSTOFFLEISTEN ПЛИНТУС ПВХ	48
	KSZTAŁTOWNIKI DLA MAJSTERKOWICZÓW DIY PROFILES BASTLERPROFILE ПРОФИЛИ ДЛЯ ОТДЕЛОЧНЫХ РАБОТ	54
	PROFILE BUDOWLANE PVC PVC DIY PROFILES DIE KUNSTOFFBAUPROFILLE СТРОЙПРОФИЛИ ПВХ	62
	LISTWY WYKOŃCZENIOWE PVC PVC FINISHING PROFILES KUNSTOFFABSCHLUSSPROFILE ЛАМИНИРОВАННЫЕ ПРОФИЛИ ПВХ	68
	LISTWY DO GLAZURY I TERAKOTY PVC PVC STRIPS FOR GLAZE AND TERAKOTA TILES FLIESENKUNSTOFFPROFILE ПРОФИЛИ ДЛЯ КАФЕЛЯ ПВХ	74

PIKTOGRAMY

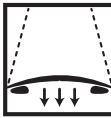
PICTOGRAMS | PIKTOGRAMME | ПИКТОГРАММЫ

	Listwa aluminiowa Aluminium strip Aluminiumleiste angefertigte Профиль сделанный из алюминия		Listwa anodowana polerowana na wysoki połysk Anodized and polished on high gloss profile Eloxierte Hochglanzleisten Профиль анодированный и полированный до блеска
	Listwa z PVC PVC strip Leisten aus PVC Профиль из ПВХ		Listwa elektropolerowana Electropolished strip Leiste mit elektroliert Планка электрополированная
	Listwa mosiężna Brass strip Messingleiste Латунный профиль		Listwa przykręcana Screwed strip Leiste angeschraubte Порожек прикручиваемый
	Listwa z powłoką anodowaną Strip with anodized coating Leiste mit Aluminiumschicht Профиль с покрытием анодированным		Listwa samoprzylepna Self-adhesive strip Leiste selbstklebend Профиль на самоклеяке
	Listwa okleinowana Laminated strip Leiste mit Furnier Профиль шпонируемый		Listwa szybkiego montażu Quick installation strip Leiste, easy fix Планка быстрый монтаж
	Listwa lakierowana Lacquered strip Lackierte Leiste Профиль окрашенный		Listwa wykończeniowa gięta Finishing bendable strip Biegeleisten Профиль отделочный для изгибов
	Listwa z uszczelką silikonową Strip with silicone gasket Leiste mit Silikondichtung Профиль с силиконовым уплотнителем		Listwa z zaczepami do wykładzin i dywanów Strip with fastenings to floor coverings and carpets Leiste mit Haken zu den Bodenbelägen und den Teppichen Планка с держателями для ковровина и ковров



Produkt dostępny na zamówienie

Product available on request
Nur auf Bestellung
Товар доступен на заказ

Aktualna lista produktów dostępna w 72 h znajduje się w informacji logistycznej zamieszczonej na www.effector.com.pl

Please, visit www.effector.com.pl to find logistic information and current list of products available in 72 hour service.



O NAS



Effector S.A. istnieje od 1993 roku i jest dziś jedną z wiodących firm w zakresie powierzchniowej i mechanicznej obróbki aluminium. Wieloletnie doświadczenie pracowników oraz nowoczesny park maszynowy, umożliwiający stosowanie zróżnicowanych metod przetwarzania, zaowocowały kompleksową ofertą w zakresie prefabrykacji aluminium: stolarki okiennodrzwiowej, okapników rynnowych i progów drzwiowych, systemów okładzin okiennych, szerokiej gamy listew wykończeniowych i elementów aranżacji wnętrza marki Effector.

Najwyższą jakość produktów i świadczonych usług potwierdza Zintegrowany System Zarządzania Jakością i Ochroną Środowiska, zgodny z normami z serii ISO 9001 / ISO 14001 oraz certyfikaty Qualanod i Qualicoat. Produkty oferowane przez firmę zyskują uznanie odbiorców oraz ekspertów, którzy przyznali produktom marki Effector wiele prestiżowych nagród, certyfikatów i wyróżnień.

Firma Effector opiera swoją strategię na wysokiej jakości, najwyższych standardach obsługi klienta oraz nowoczesnych rozwiązaniach w zakresie technologii produkcji. Produkty tej marki charakteryzują krótkie terminy dostaw, profesjonalny serwis i doradztwo. Firma dostarcza swoje wyroby do wielu krajów Europy oraz Azji.



ABOUT US

Effector S.A. was set up in 1993. Nowadays, it is one of the leading companies specializing in surface and mechanical aluminium treatment. Experienced employees and modern machinery, which enables us to use various treatment methods, resulted in comprehensive offer of aluminium pre-fabrication: window and door production, gutter drips and door thresholds, systems of window linings, wide range of finishing strips and elements of interior design produced by Effector.

The highest quality of products and services is confirmed by the Integrated System of Quality and Environmental Management, in accordance with the standards from series ISO 9001/ ISO 14001, as well as Qualanod and Qualicoat certificates. Products offered by our company gained recognition from clients and experts who gave Effector's products numerous prestigious awards, certificates, and distinctions.

Effector bases its strategy on high quality standards of customer service and modern solutions in production technology. This brand's products are characterized by short delivery, professional service and counseling. The company delivers its products to numerous countries in Europe and Asia.





ARANŻACJE WNĘTRZ



Dobry pomysł na wnętrze to nie tylko ciekawa aranżacja, funkcjonalne rozwiązanie czy nastrojowe oświetlenie. Dziś liczy się przede wszystkim jakość wykończenia – to jeden z najważniejszych elementów, od którego zależy końcowy efekt wyglądu pomieszczeń.

Pamiętaj, że odpowiednie urządzenie wnętrza ma istotny wpływ na Twoje dobre samopoczucie każdego dnia.

Listwy wykończeniowe i elementy aranżacji wnętrza to nasza pasja. Asortyment oferowany przez firmę EFFECTOR, obejmuje szeroką gamę produktów z aluminium oraz PVC.



INTERIOR DESIGN



Good ideas for interiors are not only interesting design, functional solutions or mood lightings. What counts nowadays is mainly the quality finish – this is one of the most important elements and the end result of interior design depends on it.

Remember that suitable interior design has a significant impact on Your everyday mood.

Finishing strips and interior design elements are our passion. The range of products offered by EFFECTOR includes a wide variety of aluminium and PVC products.



ALUMINIOWE LISTWY WYKOŃCZENIOWE



Wnętrza mieszkań, domów, biur, a także budynków użyteczności publicznej, kształtujemy w taki sposób, by mogły pełnić jednocześnie wiele funkcji, zgodnych z naszymi potrzebami. Podłogi w poszczególnych pomieszczeniach wiernie odzwierciedlają aktualne trendy, a więc są wykonane z bardzo różnorodnych materiałów. Najczęściej łączymy drewno, panele, parkiety i wykładziny z płytkami ceramicznymi, gresem lub kamieniem naturalnym.

Effect Standard to szeroka kolekcja profili, zapewniająca estetyczne, łatwe i szybkie połączenie różnorodnych powierzchni podłóg. Jest ona dedykowana pomieszczeniom szczególnie intensywnie eksploatowanym.

W tej grupie obok elementów łączeniowych i zakończeniowych do płaskich powierzchni, znajdziemy również kątowniki i listwy schodowe, obecnie wzbogacone o grupę kątowników z taśmą antypoślizgową. Ciekawą propozycją są również profile do łączenia i wykończenia powierzchni dywanowych oraz wykładzinowych. Oferta profili mosiężnych zainteresuje z pewnością osoby preferujące stylowy wystrój wnętrza, ceniące trwałość i bezpretensjonalną elegancję.

We shape the interiors of flats, houses, offices and public buildings in order to create places that can perform a variety of functions adjusted to our needs. Floorings are designed keeping in mind new trends so they are made of various materials. Generally, we connect wood, panels, parquet and coverings with ceramic tiles, tiles and natural stone.

Effect Standard is a wide collection of profiles, providing clean, easy and fast connection to a variety of floor surfaces. It is dedicated to interiors intensively exploited.

In this group, next to the joining and ending elements to flat surfaces, there can be find also the angle profiles and stairnoising profiles, now enriched with antislip tape. An interesting proposal also includes profiles for joining and finishing carpets and other coverings. Brass profiles offer interested people which prefer a stylish interior, valuable sustainability and unpretentious elegance.

ALUMINIUM
FINISHING STRIPS

DIE ALUMINIUMLEISTEN

АЛЮМИНЕВЫЕ ОТДЕЛОЧНЫЕ
ПРОФИЛИЗ



ALUMINIUM ANODOWANE

ANODISED ALUMINIUM | ALUMINIUM ELOXIERT | АНОДИРОВАННЫЙ АЛЮМИНИЙ

złoto - 00	srebro - 01	inox - 71	inox szczotkowany - 07	szampan - 02
gold Gold золото	silver Silber серебро	inox Inox инокс	brushed inox Gebürstet Inox щеткой инокс	champagne Champagne шампанское
brąz - 03	oliwka - 04	czarny - 005		
bronze Braun коричневый	olive Olive оливка	black Schwarz черный		



ALUMINIUM OKLEINOWANE

VENEERED ALUMINIUM | ALUMINIUM UMMANTELT | ЛАМИНИРОВАННЫЙ АЛЮМИНИЙ

buk - 08	buk jasny - 28	buk czerwony - 38	dąb - 09	dąb jasny - 29
beech Buche бук	light beech Buche hell светлый бук	copper beech Blutbuche красный бук	oak Eiche дуб	light oak Eiche hell светлый дуб
dąb złoty - 0909	wiśnia - 22	wiśnia jasna - 2201	kasztan - 31	kasztan japoński - 3101
golden oak Eiche Gold дуб золотистый	cherry Kirsch-baum вишня	bright cherry-tree Kirschbaum hell вишня светлая	chestnut Kastanie каштан	Japanese chestnut Japanische Kastanie каштан японский
sosna - 30	sosna biała - 35	klon - 25	olcha - 23	hikora - 32
pine Kiefer сосна	white pine Kiefer Weiss белая сосна	maple Ahorn клен	alder Erle ольха	hickory Hickorybaum хикора

ALUMINIUM OKLEINOWANE

VENEERED ALUMINIUM | ALUMINIUM UMMANTELT | ЛАМИНИРОВАННЫЙ АЛЮМИНИЙ

















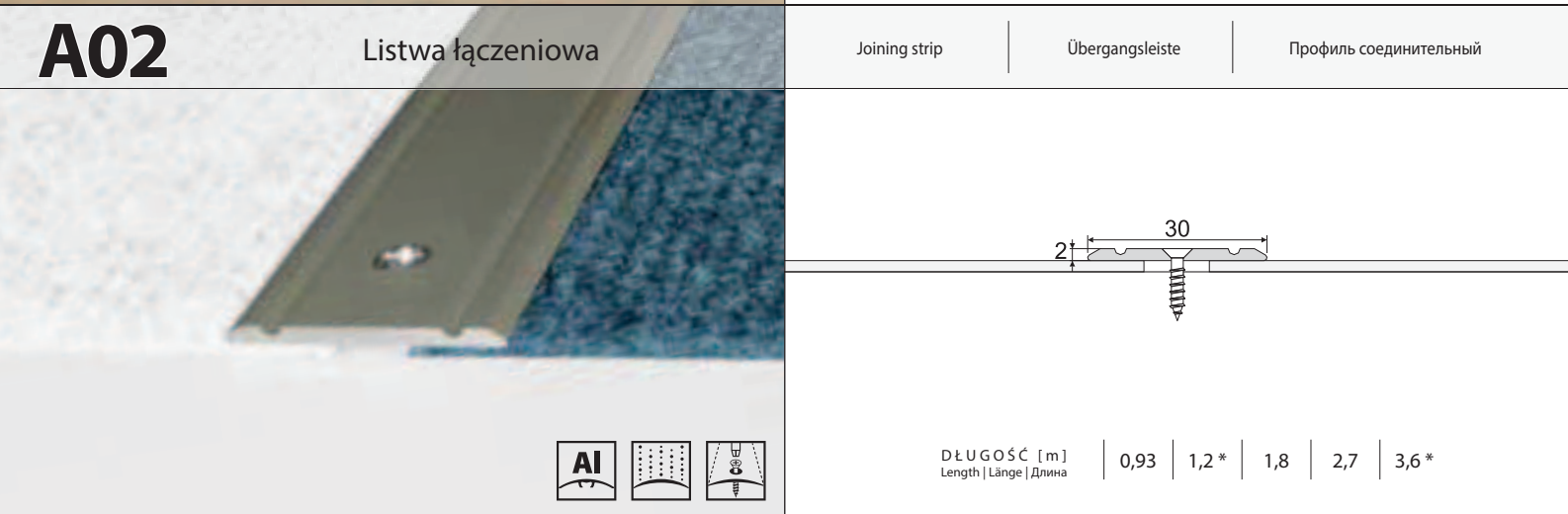

wiąz - 34	mahoń - 24	mahoń Togo - 2402	afrezja - 33	orzech Chile - 2701
elm Ulme вяз	mahogany Mahagoni красное дерево	Togo mahogany Mahagoni Togo красное дерево Togo	afrezy Afrezy афрезия	Chile nut Nussbaum Chile орех Чили
teak indyjski - 4500	heban afrykański - 4501	wenge Kongo - 4201	dąb bielony - 20901	dąb Mocca - 20902
Indian teak Indischer Teak тик Индийский	African ebony Afrikanischer Heban черное фриканское Дерево	Congo wenge Wenge Kongo венге Конго	white oak Eiche gebleicht беленный дуб	Mocca oak Eiche Mocca дуб Моща
dąb antyczny - 20903	dąb arctic - 20904	dąb bursztynowy - 20905	dąb koniakowy - 20906	dąb piaskowy - 20907
antique oak Eiche antik дуб античный	arctic oak Eiche Arctic дуб арктиц	Amber oak Eiche Bernstein янтарный дуб	Cognac oak Eiche Cognac коняковый дуб	Sandy oak Eiche Sand песочный дуб
dąb piwny - 20908	dąb zamkowy - 20910	merbau - 20944		
Bery oak Eiche Hellbraun пивной дуб	Castle oak Schloss Eiche замочный дуб	merbau Merbau мербау		

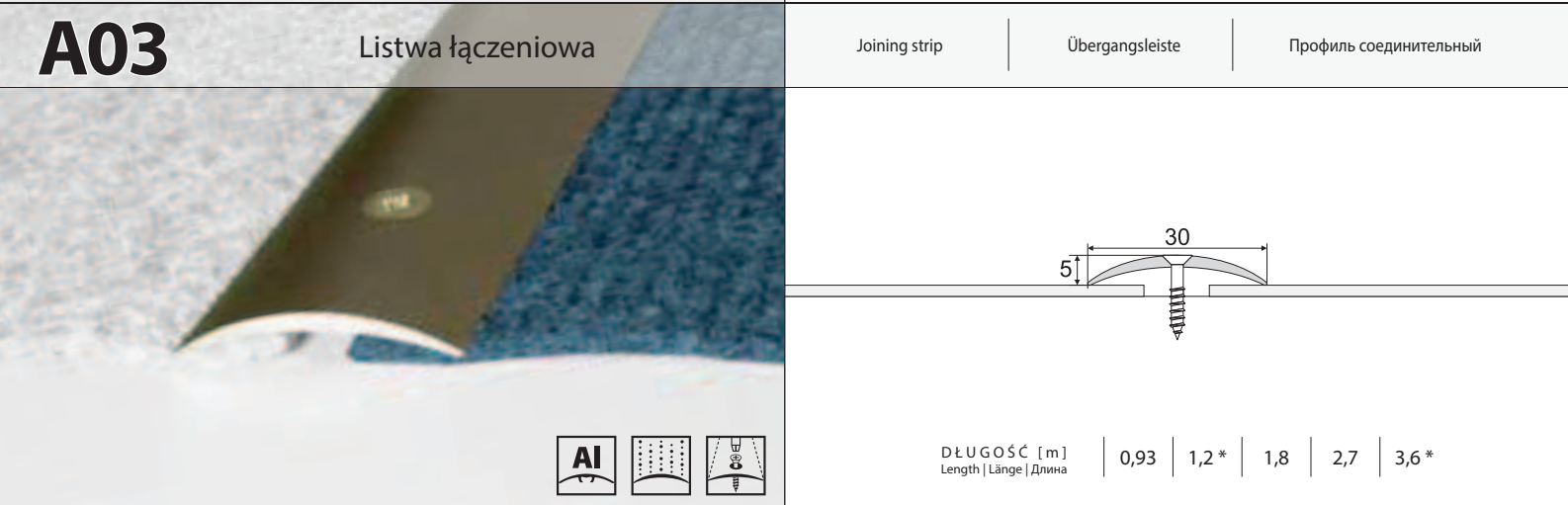
MOSIĄDZ

BRASS | MESSING | ЛАТУНЬ

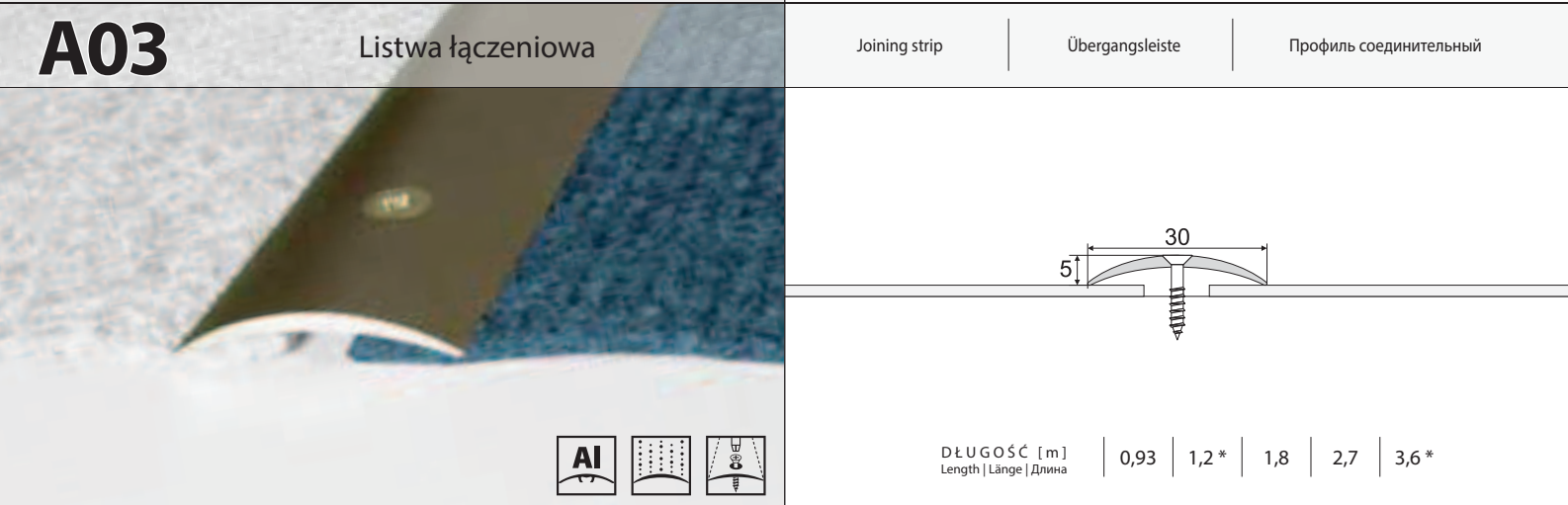
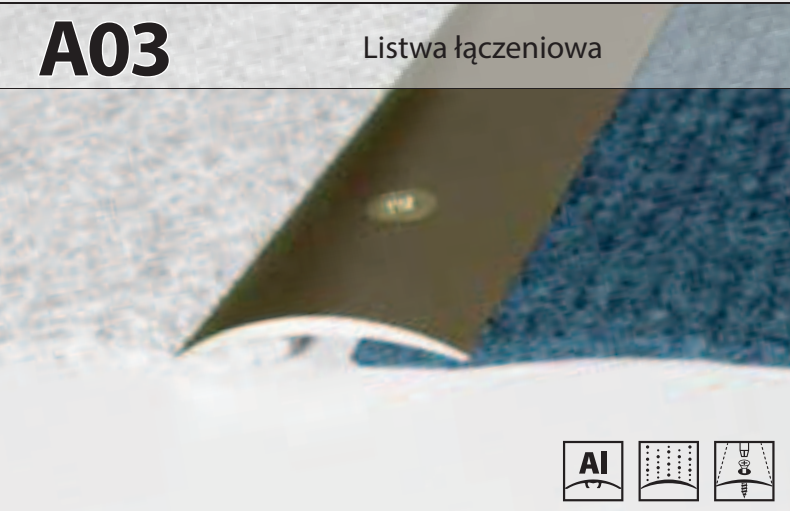

mosiądz - 05		
brass	Messing	латунь

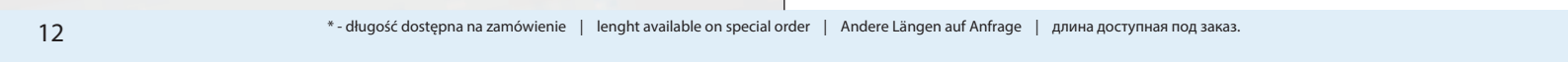
<p>A01 Listwa mocująca krawędzie wykładzin</p>  <p>AI   </p>	<p>Floor covering edge fixing strip</p>	<p>Abschlussleiste</p>	<p>Профиль для закрепления краев покрытий</p>					
 <p>DŁUGOŚĆ [m] Length Länge Длина</p> <table border="1"> <tr> <td>0,9</td> <td>1,2 *</td> <td>1,8</td> <td>2,7</td> <td>3,6 *</td> </tr> </table>				0,9	1,2 *	1,8	2,7	3,6 *
0,9	1,2 *	1,8	2,7	3,6 *				
<p>A02 Listwa łączeniowa</p>  <p>AI   </p>	<p>Joining strip</p>	<p>Übergangsstreife</p>	<p>Профиль соединительный</p>					
 <p>DŁUGOŚĆ [m] Length Länge Длина</p> <table border="1"> <tr> <td>0,93</td> <td>1,2 *</td> <td>1,8</td> <td>2,7</td> <td>3,6 *</td> </tr> </table>				0,93	1,2 *	1,8	2,7	3,6 *
0,93	1,2 *	1,8	2,7	3,6 *				
<p>A02 Listwa łączeniowa SAMOPRZYLEPNA</p>  <p>ZAM AI   </p>	<p>Joining strip SELF-ADHESIVE</p>	<p>Übergangsstreife SELBSTKLEBEND</p>	<p>Профиль соединительный самоклеющийся</p>					
 <p>DŁUGOŚĆ [m] Length Länge Длина</p> <table border="1"> <tr> <td>0,93</td> <td>1,2 *</td> <td>1,8</td> <td>2,7</td> <td>3,6 *</td> </tr> </table>				0,93	1,2 *	1,8	2,7	3,6 *
0,93	1,2 *	1,8	2,7	3,6 *				
<p>A03 Listwa łączeniowa</p>  <p>AI   </p>	<p>Joining strip</p>	<p>Übergangsstreife</p>	<p>Профиль соединительный</p>					
 <p>DŁUGOŚĆ [m] Length Länge Длина</p> <table border="1"> <tr> <td>0,93</td> <td>1,2 *</td> <td>1,8</td> <td>2,7</td> <td>3,6 *</td> </tr> </table>				0,93	1,2 *	1,8	2,7	3,6 *
0,93	1,2 *	1,8	2,7	3,6 *				

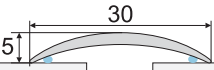
Профиль соединительный самоклеющийся	Übergangsleiste SELBSTKLEBEND	Joining strip SELF-ADHESIVE			
					
DŁUGOŚĆ [m] Length Länge Длина	0,93	1,2 *	1,8	2,7	3,6 *

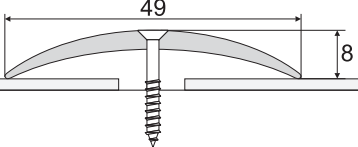

Профиль соединительный	Übergangsleiste	Joining strip			
					
DŁUGOŚĆ [m] Length Länge Длина	0,93	1,2 *	1,8	2,7	3,6 *

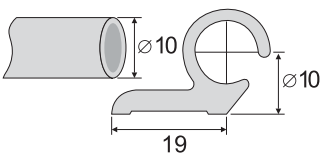

Ковродержатель для ступенек с креплением	Stufenteppichstange mit Befestigung	Stair floor-cloth fastening bar with mounting holder			
					
DŁUGOŚĆ [m] Length Länge Длина	0,8	0,9	1,0	1,2 *	1,35

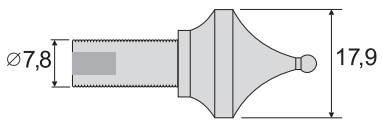

Наконечник для ковродержателя	Spitz Abschluss	Ends for bars - Christmas tree type
		



A06 Z2

Zakończenie do prętów - kulkowe

Ends for bars - ball type

Runder Abschluss

Наконечник для стержня - сферический

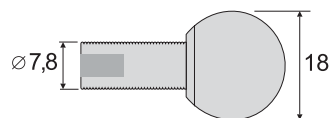

A08

Listwa łączeniowa

Joining strip

Übergangsleiste

Профиль соединительный

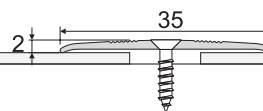
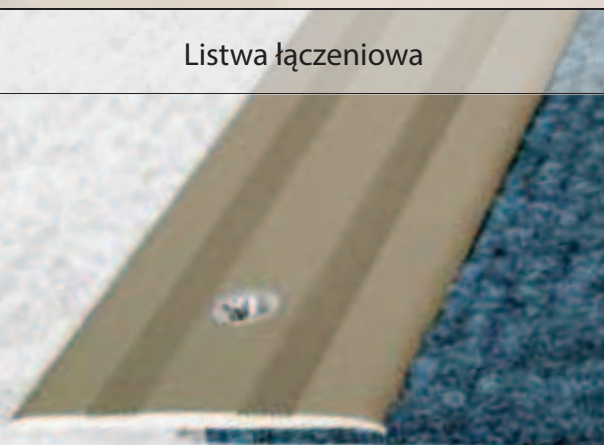

DŁUGOŚĆ [m] | 0,93 | 1,2 * | 1,8 | 2,7 | 3,6 *
Length | Länge | Длина

A08

Listwa łączeniowa SAMOPRZYLEPNA

Joining strip SELF-ADHESIVE

Übergangsleiste SELBSTKLEBEND

Профиль соединительный самоклеющийся

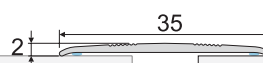

DŁUGOŚĆ [m] | 0,93 | 1,2 * | 1,8 | 2,7 | 3,6 *
Length | Länge | Длина

A10

Listwa progowa z wkładką antypoślizgową (guma)

Sill strip with anti-skid lining (rubber)

Schwelleleiste mit Anti-Rutsch Einsatz (Gummi)

Профиль для порога с антискользящей вставкой (резиновой)

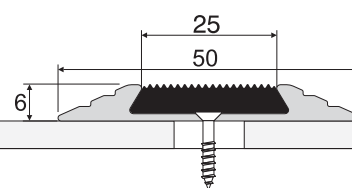

KOLORY GUMY	RUBBER COLOURS	FARBEN	ЦВЕТА РЕЗИНЫ
szary - 89	grey	Grau	серый
brąz - 86	brown	Braun	коричневый
czarny - 88	black	Schwarz	черный

DŁUGOŚĆ [m] | 0,93 | 1,2 * | 1,8 | 2,7 | 3,6 *
Length | Länge | Длина

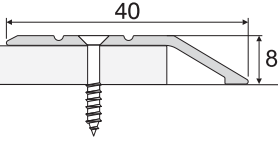
Профиль соединительный самоклеющийся	Übergangsleiste SELBSTKLEBEND	Joining strip SELF-ADHESIVE		
				
DŁUGOŚĆ [m] Length Länge Длина	0,9	1,8	2,7	3,6 *

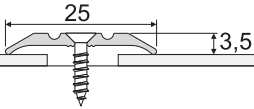

Профиль соединительный	Übergangsleiste	Joining strip		
				
DŁUGOŚĆ [m] Length Länge Длина	0,93	1,8	2,7	3,6 *

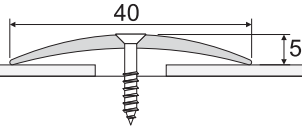

Профиль соединительный	Übergangsleiste	Joining strip		
				
DŁUGOŚĆ [m] Length Länge Длина	0,93	1,8	2,7	3,6 *

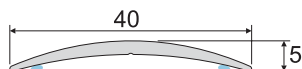

Профиль соединительный самоклеющийся	Übergangsleiste SELBSTKLEBEND	Joining strip SELF-ADHESIVE		
				
DŁUGOŚĆ [m] Length Länge Длина	0,93	1,8	2,7	3,6 *



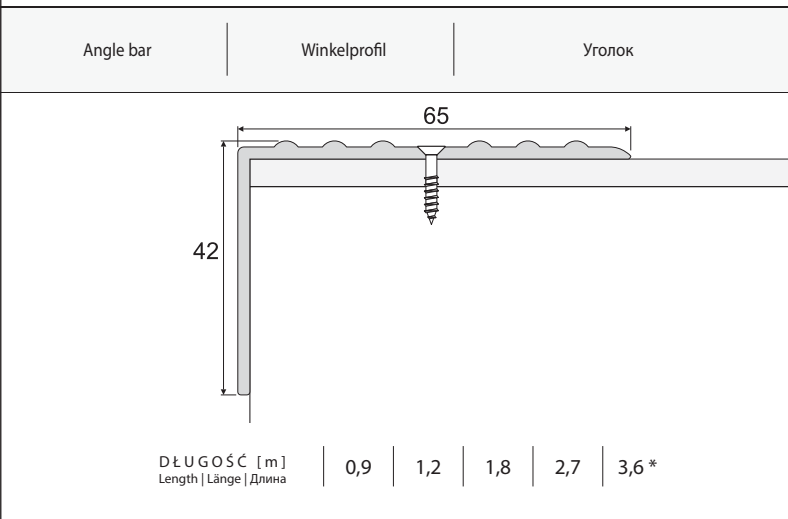
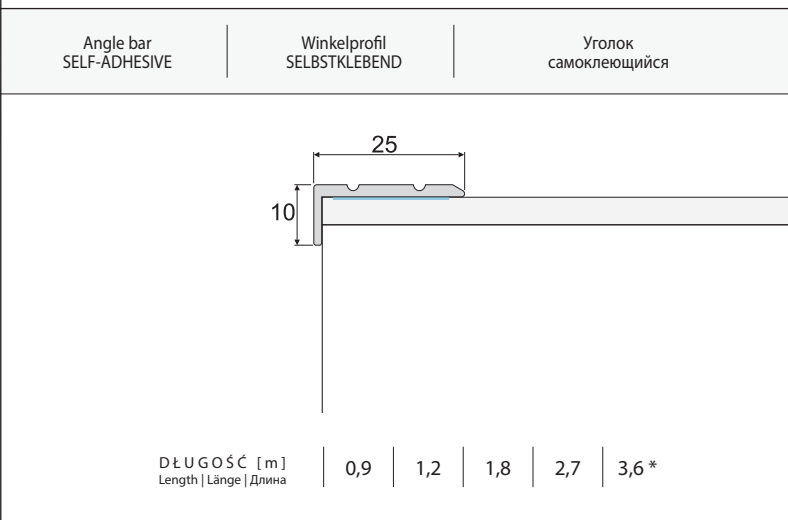
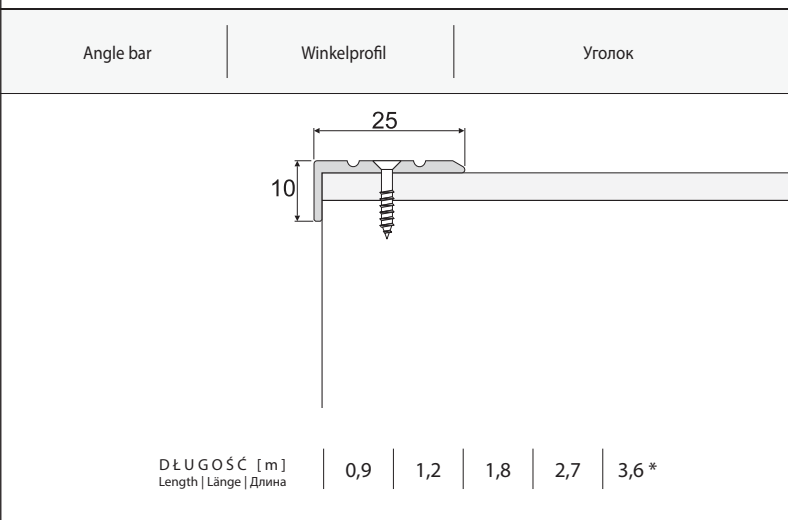
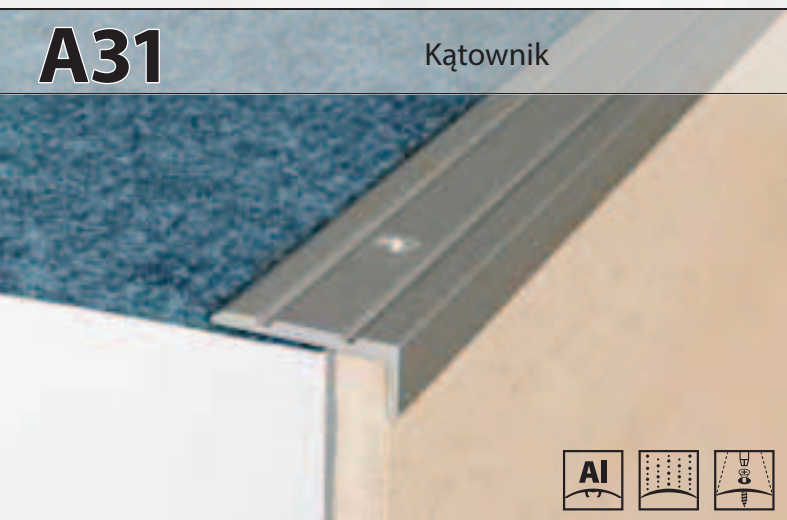
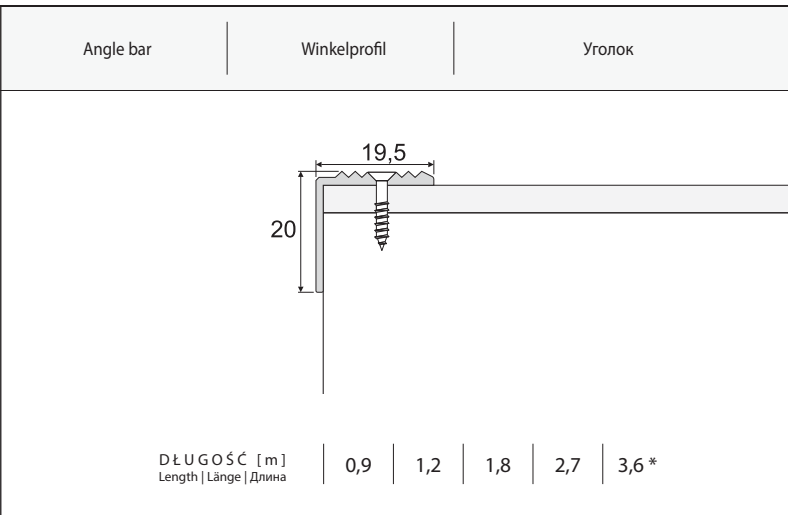
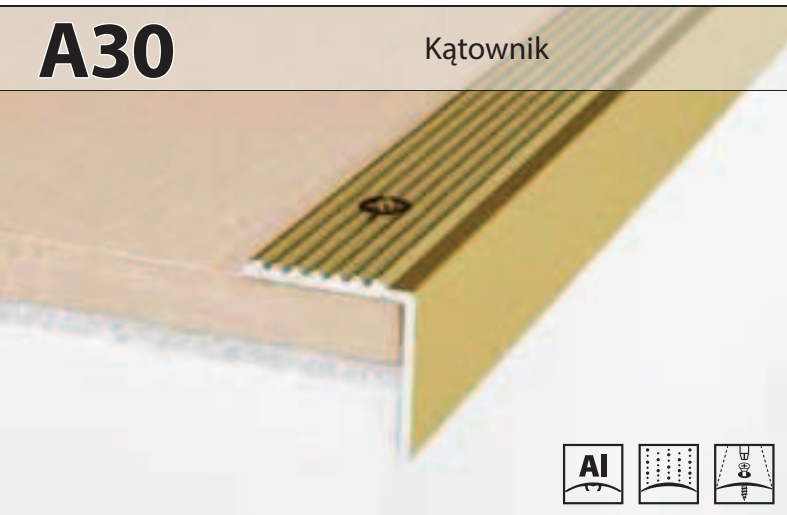

Уголок	Winkelprofil	Angle bar					
<p>DŁUGOŚĆ [m] Length Länge Длина</p> <table border="1"> <tr> <td>0,9</td> <td>1,2</td> <td>1,8</td> <td>2,7</td> <td>3,6 *</td> </tr> </table>			0,9	1,2	1,8	2,7	3,6 *
0,9	1,2	1,8	2,7	3,6 *			

Kątownik **A33**

AI

Уголок	Winkelprofil	Angle bar					
<p>DŁUGOŚĆ [m] Length Länge Длина</p> <table border="1"> <tr> <td>0,9</td> <td>1,2</td> <td>1,8</td> <td>2,7</td> <td>3,6 *</td> </tr> </table>			0,9	1,2	1,8	2,7	3,6 *
0,9	1,2	1,8	2,7	3,6 *			

Kątownik **A34**

AI

Уголок	Winkelprofil	Angle bar					
<p>DŁUGOŚĆ [m] Length Länge Длина</p> <table border="1"> <tr> <td>0,9</td> <td>1,2</td> <td>1,8</td> <td>2,7</td> <td>3,6 *</td> </tr> </table>			0,9	1,2	1,8	2,7	3,6 *
0,9	1,2	1,8	2,7	3,6 *			

Kątownik **A35**

AI

Уголок	Winkelprofil	Angle bar					
<p>DŁUGOŚĆ [m] Length Länge Длина</p> <table border="1"> <tr> <td>0,9</td> <td>1,2</td> <td>1,8</td> <td>2,7</td> <td>3,6 *</td> </tr> </table>			0,9	1,2	1,8	2,7	3,6 *
0,9	1,2	1,8	2,7	3,6 *			





Kątownik **A36**

AI

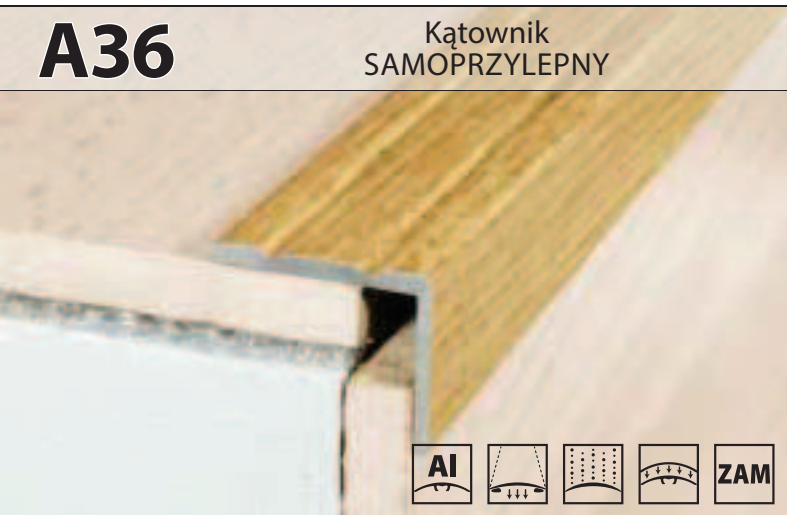
A36

Kątownik SAMOPRZYLEPNY



Angle bar SELF-ADHESIVE	Winkelprofil SELBSTKLEBEND	Уголок самоклеющийся
----------------------------	-------------------------------	-------------------------

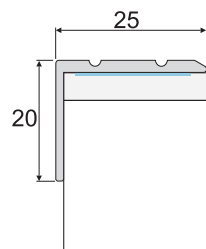

DŁUGOŚĆ [m] Length Länge Длина	0,9	1,2	1,8	2,7	3,6 *
---------------------------------------	-----	-----	-----	-----	-------

A38

Listwa schodowa z wkładką antypoślizgową







Stairs slat with anti-sliding lining	Stufenleiste mit Anti-Rutsch-Einsatz (Gummi)	Профиль для ступеньки с антискользящей вставкой (резиновой)
---	---	---

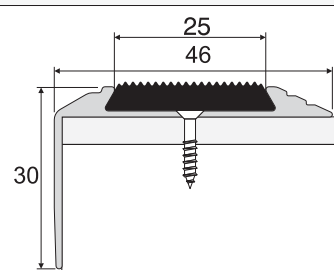





KOLORY GUMY	RUBBER COLOURS	FARBEN	ЦВЕТА РЕЗИНЫ
szary - 89	grey	Grau	серый
brąz - 86	brown	Braun	коричневый
czarny - 88	black	Schwarz	черный

DŁUGOŚĆ [m] Length Länge Длина	0,9	1,2	1,8	2,7	3,6 *
---------------------------------------	-----	-----	-----	-----	-------

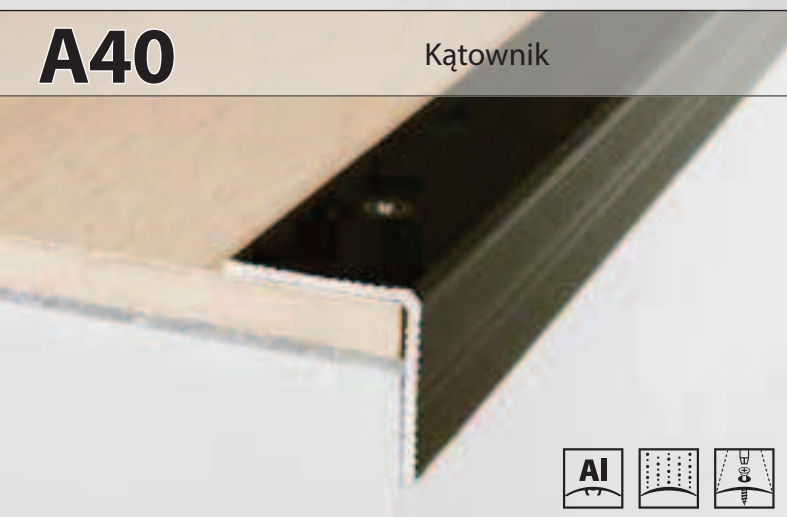
A40

Kątownik



Angle bar	Winkelprofil	Уголок
-----------	--------------	--------

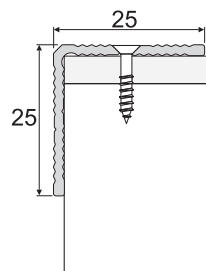

DŁUGOŚĆ [m] Length Länge Длина	0,9	1,2	1,8	2,7	3,6 *
---------------------------------------	-----	-----	-----	-----	-------

A40

Kątownik SAMOPRZYLEPNY









Angle bar SELF-ADHESIVE	Winkelprofil SELBSTKLEBEND	Уголок самоклеющийся
----------------------------	-------------------------------	-------------------------

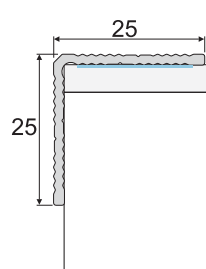

DŁUGOŚĆ [m] Length Länge Длина	0,9	1,2	1,8	2,7	3,6 *
---------------------------------------	-----	-----	-----	-----	-------

Уголок выравнивающий | Abschlussprofil | Dilatation angle

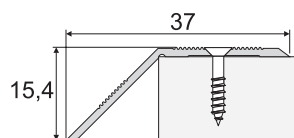

DŁUGOŚĆ [m] | Length | Länge | Длина
0,9 | 1,2 * | 1,8 | 2,7 | 3,6 *



Уголок | Winkelprofil | Angle bar

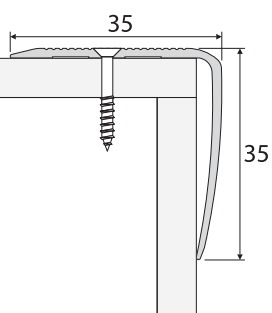

DŁUGOŚĆ [m] | Length | Länge | Длина
0,9 | 1,2 * | 1,8 | 2,7 | 3,6 *

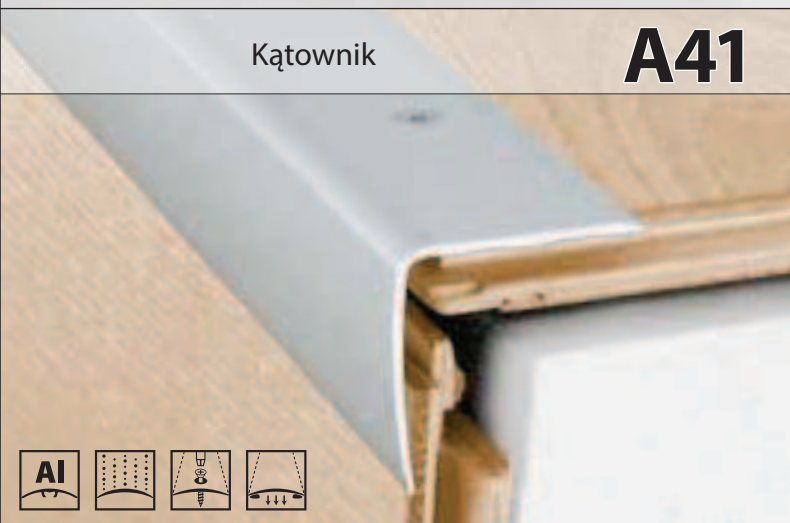

Уголок | Winkelprofil | Angle bar

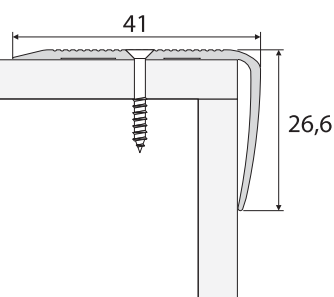

DŁUGOŚĆ [m] | Length | Länge | Длина
0,9 | 1,2 * | 1,8 | 2,7 | 3,6 *



Угол порожек с противоскользящей лентой | Winkelprofil mit Anti-Rutsch-Einsatz (Band) | Angle bar with anti-skidding tape

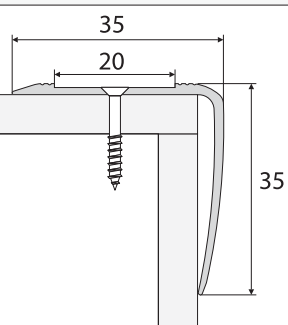

DŁUGOŚĆ [m] | Length | Länge | Длина
0,9 | 1,2 * | 1,8 | 2,7 | 3,6 *



A44

Kątownik
z taśmą antypoślizgową

Angle bar with
anti-skidding tape

Winkelprofil mit Anti-
Rutsch-Einsatz (Band)

Угол порожек
с противоскользящей
лентой

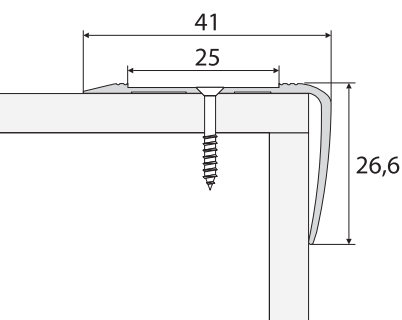

DŁUGOŚĆ [m] Length Länge Длина	0,9	1,2 *	1,8	2,7	3,6 *
---------------------------------------	-----	-------	-----	-----	-------

A45

Listwa dylatacyjna
SAMOPRZYLEPNA

Dilatation strip
SELF-ADHESIVE

Dehnungsleiste
SELBSTKLEBEND

Профиль
выравнивающий
самоклеющийся

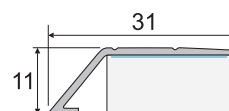
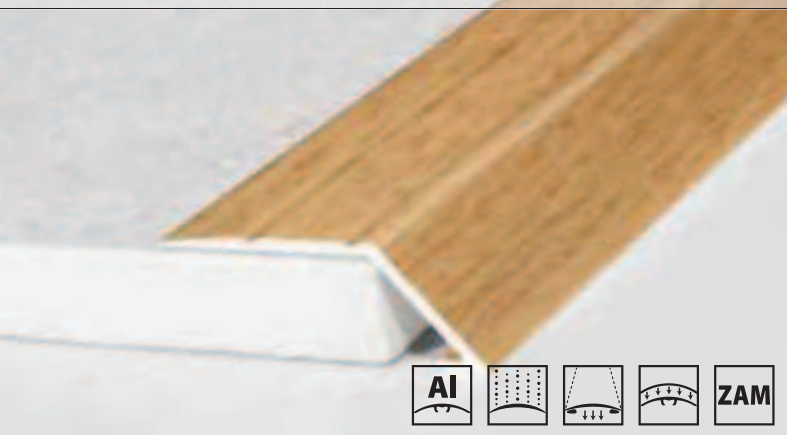

DŁUGOŚĆ [m] Length Länge Длина	0,9	1,2 *	1,8	2,7	3,6 *
---------------------------------------	-----	-------	-----	-----	-------

A47

Listwa dylatacyjna
SAMOPRZYLEPNA

Dilatation strip
SELF-ADHESIVE

Dehnungsleiste
SELBSTKLEBEND

Профиль
выравнивающий
самоклеющийся

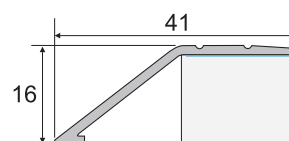
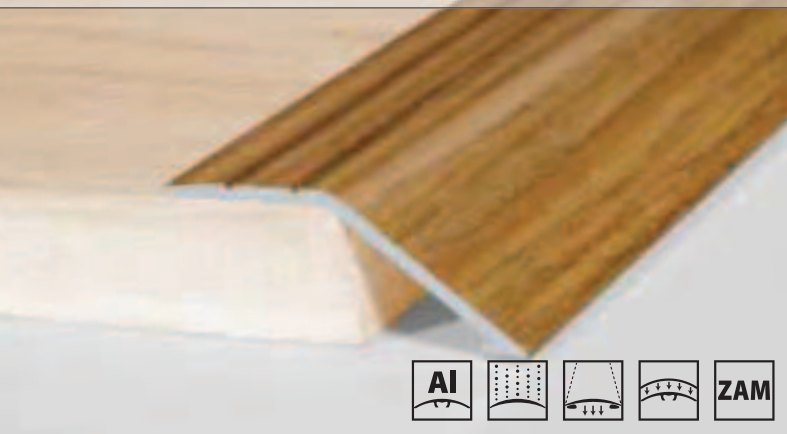

DŁUGOŚĆ [m] Length Länge Длина	0,9	1,2 *	1,8	2,7	3,6 *
---------------------------------------	-----	-------	-----	-----	-------

A48

Listwa najazdowa

Approaching strip

Ausgleichsleiste

Профиль наклонный

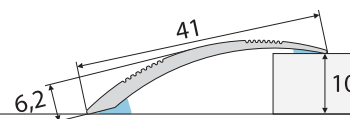
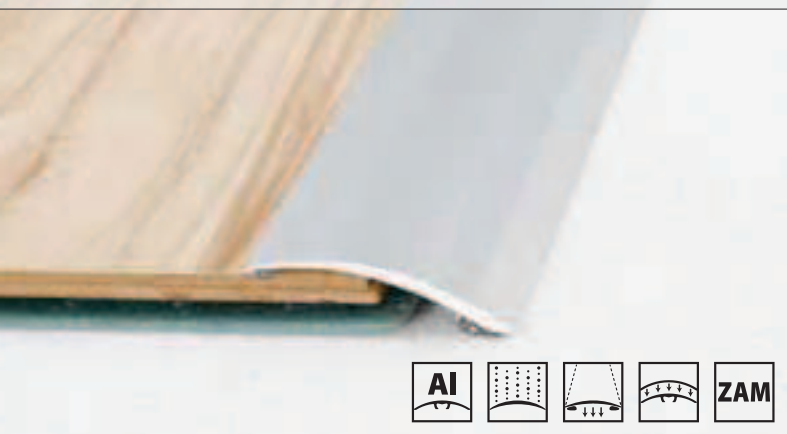

DŁUGOŚĆ [m] Length Länge Длина	1,0	2,0	3,0
---------------------------------------	-----	-----	-----

Профиль наклонный

Ausgleichsleiste

Approaching strip

Listwa najazdowa

A49

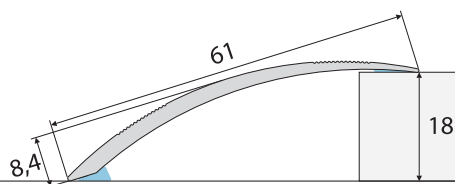

DŁUGOŚĆ [m]
Length | Länge | Длина

1,0 | 2,0 | 3,0



профиль для ступеньки

Stufenleiste

Stair slat

Listwa schodowa



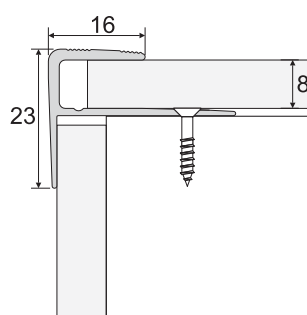











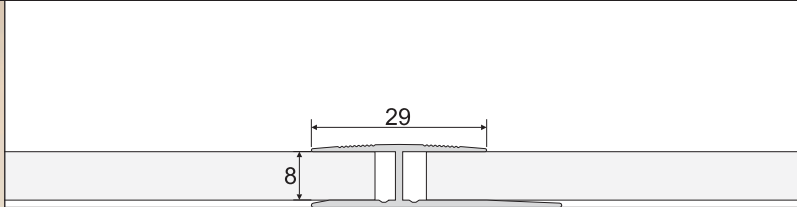

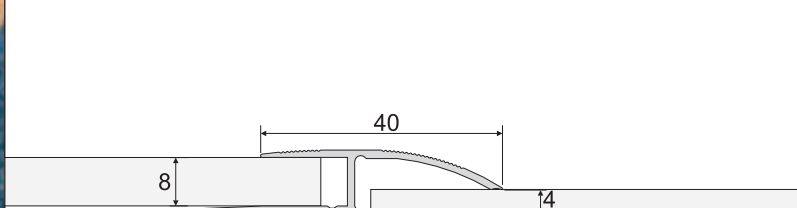

A60

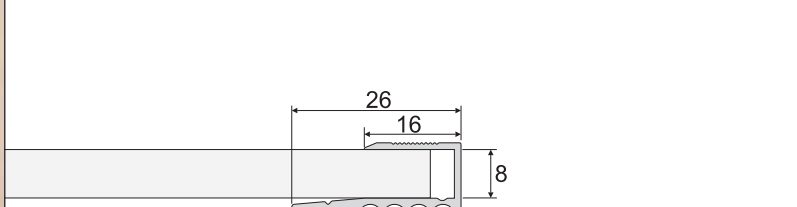

DŁUGOŚĆ [m]
Length | Länge | Длина

0,9 | 1,2 * | 1,8 | 2,7 | 3,6 *

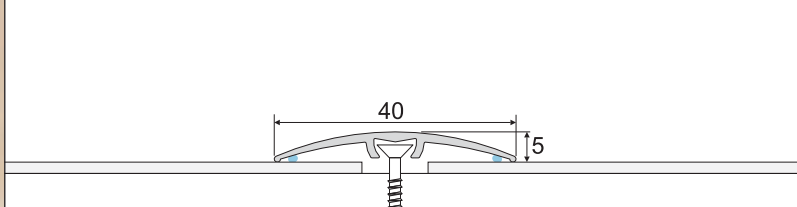

<p>A61 Listwa progowa łącząca</p>  <p>AI   </p>	<p>Joining sill strip</p>	<p>Übergangsleiste</p>	<p>Профиль для порога соединительный</p>					
								
<p>DŁUGOŚĆ [m] Length Länge Длина</p> <table border="1"> <tr> <td>0,9</td> <td>1,2 *</td> <td>1,8</td> <td>2,7</td> <td>3,6 *</td> </tr> </table>				0,9	1,2 *	1,8	2,7	3,6 *
0,9	1,2 *	1,8	2,7	3,6 *				
<p>A62 Listwa dylatacyjna</p>  <p>AI   </p>	<p>Dilatation strip</p>	<p>Dehnungsleiste</p>	<p>Профиль выравнивающий</p>					
								
<p>DŁUGOŚĆ [m] Length Länge Длина</p> <table border="1"> <tr> <td>0,9</td> <td>1,2 *</td> <td>1,8</td> <td>2,7</td> <td>3,6 *</td> </tr> </table>				0,9	1,2 *	1,8	2,7	3,6 *
0,9	1,2 *	1,8	2,7	3,6 *				
<p>A63 Listwa zakończeniowa</p>  <p>AI   </p>	<p>Edging strip</p>	<p>Abschlussleiste</p>	<p>Отделочный профиль</p>					
								
<p>DŁUGOŚĆ [m] Length Länge Длина</p> <table border="1"> <tr> <td>0,9</td> <td>1,2 *</td> <td>1,8</td> <td>2,7</td> <td>3,6 *</td> </tr> </table>				0,9	1,2 *	1,8	2,7	3,6 *
0,9	1,2 *	1,8	2,7	3,6 *				
<p>A64 Listwa szybkiego montażu z uszczelką silikonową</p>  <p>AI     </p>	<p>Quick-mounted strip with silicone seal</p>	<p>Leiste mit Silikondichtung, easy fix</p>	<p>Профиль для быстрого соединения с силиконовой прокладкой</p>					
								
<p>DŁUGOŚĆ [m] Length Länge Длина</p> <table border="1"> <tr> <td>0,93</td> <td>1,2 *</td> <td>1,8</td> <td>2,7</td> <td>3,6 *</td> </tr> </table>				0,93	1,2 *	1,8	2,7	3,6 *
0,93	1,2 *	1,8	2,7	3,6 *				

Профиль для быстрого соединения с силиконовой прокладкой

Leiste mit Silikondichtung, easy fix

Quick-mounted dilatation strip with silicone seal

Listwa dylatacyjna szybkiego montażu z uszczelką silikonową

A65

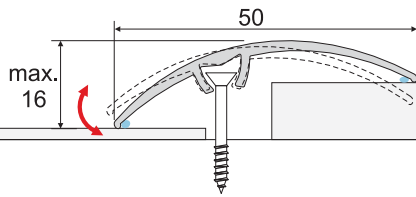

DŁUGOŚĆ [m]
Length | Länge | Длина

0,93	1,2 *	1,8	2,7	3,6 *
------	-------	-----	-----	-------



Профиль для быстрого соединения с силиконовой прокладкой

Leiste mit Silikondichtung, easy fix

Quick-mounted strip with silicone seal

Listwa szybkiego montażu z uszczelką silikonową

A66

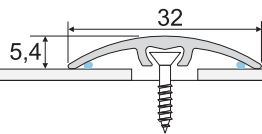

DŁUGOŚĆ [m]
Length | Länge | Длина

0,93	1,2 *	1,8	2,7	3,6 *
------	-------	-----	-----	-------

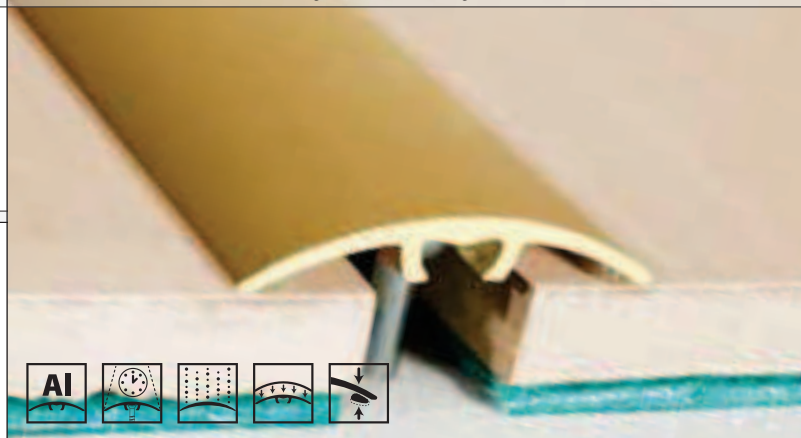

Профиль для быстрого соединения

Leiste, easy fix

Quick-mounted strip

Listwa szybkiego montażu

A68

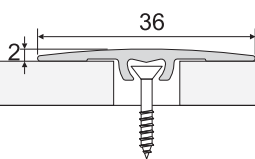

DŁUGOŚĆ [m]
Length | Länge | Длина

0,9	1,2 *	1,8	2,7	3,6 *
-----	-------	-----	-----	-------



Планка зажимная

Klemmleiste

Clamping strip

Listwa zaciskowa

A69

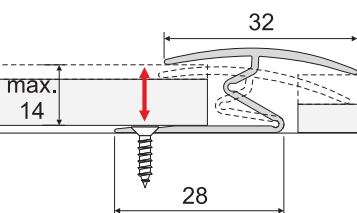

DŁUGOŚĆ [m]
Length | Länge | Длина

0,9	1,2 *	1,8	2,7	3,6 *
-----	-------	-----	-----	-------



A70

Listwa łączeniowa
SAMOPRZYLEPNA

Joining strip
SELF-ADHESIVE

Übergangsleiste
SELBSTKLEBEND

Профиль
соединительный
самоклеющийся

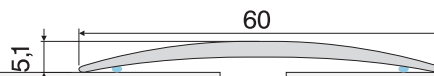

DŁUGOŚĆ [m]
Length | Länge | Длина

1,0 | 2,0 | 3,0

A71

Listwa łączeniowa
SAMOPRZYLEPNA

Joining strip
SELF-ADHESIVE

Übergangsleiste
SELBSTKLEBEND

Профиль
соединительный
самклеющийся

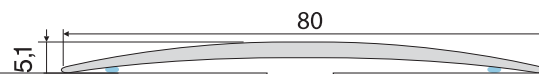
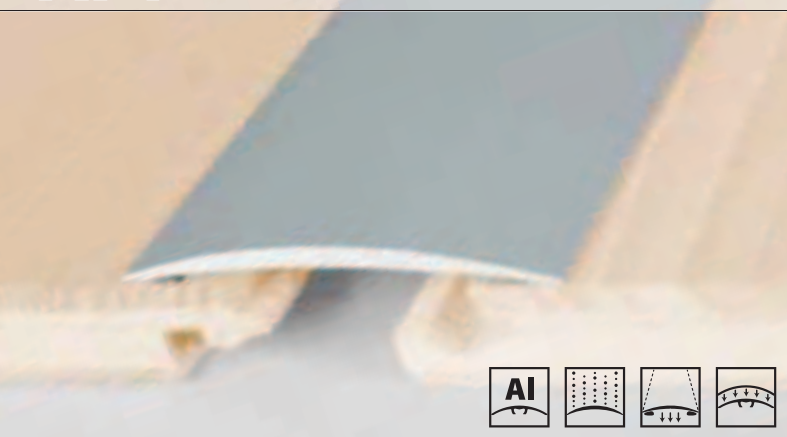

DŁUGOŚĆ [m]
Length | Länge | Длина

1,0 | 2,0 | 3,0



PROFILE DO WYKŁADZIN I DYWANÓW

PROFILES FOR FLOOR COVERINGS AND CARPETS | PROFILE FÜR BODENBELÄGE UND TEPPICHE | ПРОФИЛИ ДЛЯ НАПОЛЬНЫХ ПОКРЫТИЙ И КОВРОВ

Профиль краевой
для ковролина

Randprofil zu den
Bodenbelägen und den
Teppichen

Edge profile to floor
coverings and carpets

Profil krawędziowy
do wykładzin i dywanów

C07

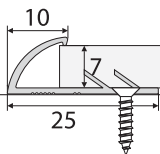

DŁUGOŚĆ [m]
Length | Länge | Длина

1,0 | 2,0 | 3,0



Угловой профиль
для ковролина
и ковра

Winkelprofil zu den
Bodenbelägen und den
Teppichen

Angle bar profile to floor
coverings and carpets

Profil kątownikowy
do wykładzin i dywanów

C23

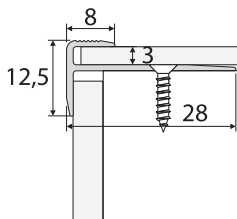

DŁUGOŚĆ [m]
Length | Länge | Длина

0,9 | 1,2 | 1,8 | 2,7



Угловой профиль
для ковролина
и ковра

Winkelprofil zu den
Bodenbelägen und den
Teppichen

Angle bar profile to floor
coverings and carpets

Profil kątownikowy
do wykładzin i dywanów

C24

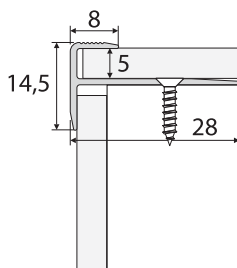

DŁUGOŚĆ [m]
Length | Länge | Длина

0,9 | 1,2 | 1,8 | 2,7



Соединительный профиль
для ковролина и ковров

Übergangprofil zu den
Bodenbelägen und den
Teppichen

Joining profile to floor
coverings and carpets

Profil łączeniowy
do wykładzin i dywanów

C61

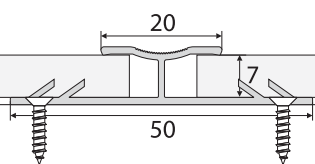

DŁUGOŚĆ [m]
Length | Länge | Длина

1,0 | 2,0 | 3,0



C68

Profil łączeniowy
do wykładzin i dywanów

Joining profile to floor
coverings and carpets

Übergangprofil zu den
Bodenbelägen und den
Teppichen

Соединительный профиль
для ковровина и ковров

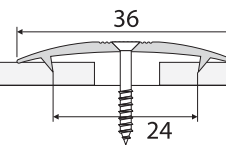

DŁUGOŚĆ [m]
Length | Länge | Длина

1,0 | 2,0 | 3,0

C69

Profil zaciskowy
do wykładzin i dywanów

Clamping profile to floor
coverings and carpets

Klemmprofil zu den
Bodenbelägen und den
Teppichen

Зажимная планка
для ковровина

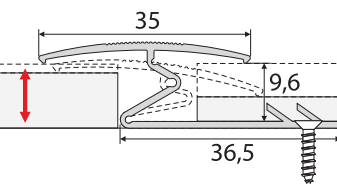







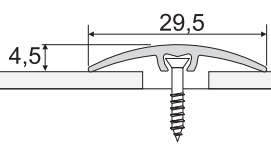

DŁUGOŚĆ [m]
Length | Länge | Длина

1,0 | 2,0 | 3,0

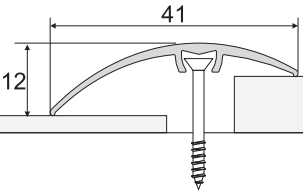

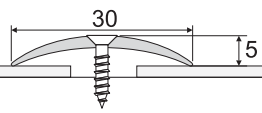
PROFILE MOSIĘŻNE

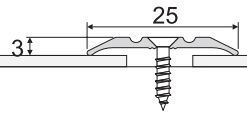
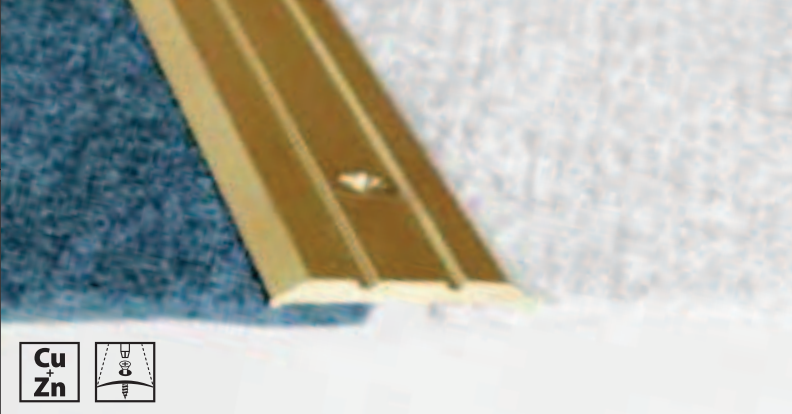
BRASS PROFILES | PROFILE AUS MESSING | ЛАТУНЬ ПРОФИЛИ

<p>Профиль быстрого соединения</p>	<p>Leiste, easy fix</p>	<p>Quick-mounted strip</p>	<p>Listwa szybkiego montażu A15</p>
 <p>DŁUGOŚĆ [m] Length Länge Длина</p> <p>1,0 2,0 3,0 *</p>			 <p>Cu Zn </p>
<p>Профиль быстрого соединения</p>	<p>Leiste, easy fix</p>	<p>Quick-mounted strip</p>	<p>Listwa szybkiego montażu A16</p>
 <p>DŁUGOŚĆ [m] Length Länge Длина</p> <p>1,0 2,0 3,0 *</p>			 <p>Cu Zn </p>
<p>Профиль соединительный</p>	<p>Übergangisleiste</p>	<p>Joining strip</p>	<p>Listwa łączeniowa A17</p>
 <p>DŁUGOŚĆ [m] Length Länge Длина</p> <p>1,0 2,0 3,0 *</p>			 <p>Cu Zn </p>
<p>Профиль для порога плоский</p>	<p>Übergangisleiste</p>	<p>Flat sill strip</p>	<p>Listwa progowa płaska A18</p>
 <p>DŁUGOŚĆ [m] Length Länge Длина</p> <p>1,0 2,0 3,0 *</p>			 <p>Cu Zn </p>

A19

Listwa progowa skośna

Skew sill strip

Schwelleleiste, angeschrägt

Профиль для порога скошенный

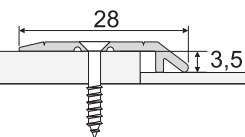
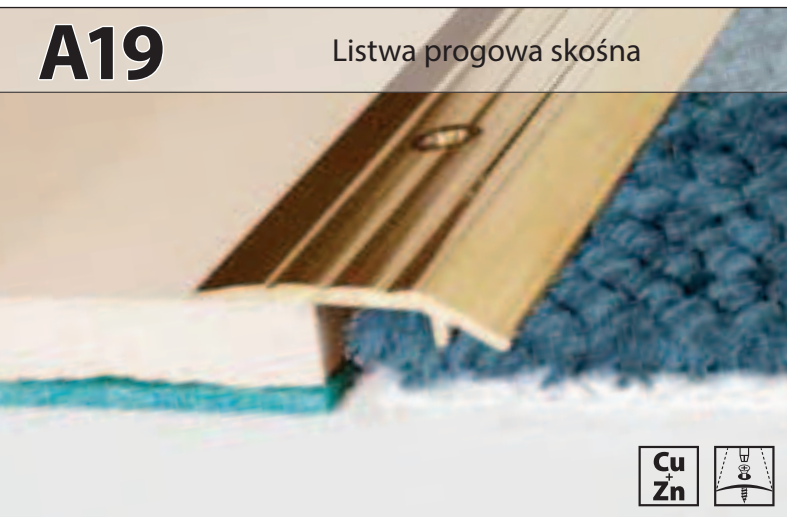

DŁUGOŚĆ [m]
Length | Länge | Длина

1,0 | 2,0 | 3,0 *

A20

Kątownik

Angle bar

Winkelprofil

Уголок

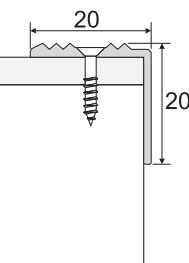

DŁUGOŚĆ [m]
Length | Länge | Длина

1,0 | 2,0 | 3,0 *

A21

Kątownik

Angle bar

Winkelprofil

Уголок

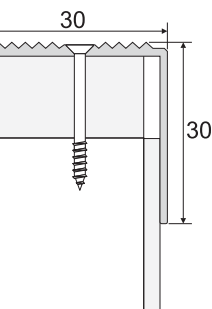

DŁUGOŚĆ [m]
Length | Länge | Длина

1,0 | 2,0 | 3,0 *

A22

Kątownik

Angle bar

Winkelprofil

Уголок

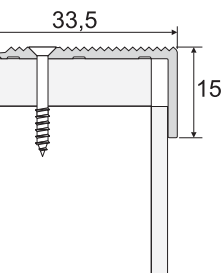

DŁUGOŚĆ [m]
Length | Länge | Длина

1,0 | 2,0 | 3,0 *



ALUMINIOWE LISTWY COKOŁOWE



Aluminiowe listwy cokołowe **Effector Multi Effect** nadają ostateczny wygląd podłodze we wnętrzu, a jednocześnie spełniają szereg praktycznych funkcji: przykrywają szczelinę dylatacyjną, umożliwiają schowanie przewodów elektrycznych oraz zabezpieczają przed zniszczeniem delikatną fakturę ścian. Profile pełnią także istotną rolę dekoracyjną, a dzięki materiałowi, z którego są wykonane, podkreślają urok minimalizmu oraz nowoczesny charakter wnętrz. Kolor i faktura aluminium nawiązują do innych elementów wyposażenia, jak meble oraz dekoracje.

Aluminium skirting boards **Effector Multi Effect** give final look to the floor. At the same time their functions are covering settlement joints, hiding electric wires and protecting the walls against damage. Profiles play also an important decorative role by highlighting, thanks to material they are made of, minimalistic and modern interiors. The colour and texture of aluminium correspond with other design elements such as furniture and ornaments.

ALUMINUM SKIRTING BOARD

ALUMINIUM SOCKELLEISTEN



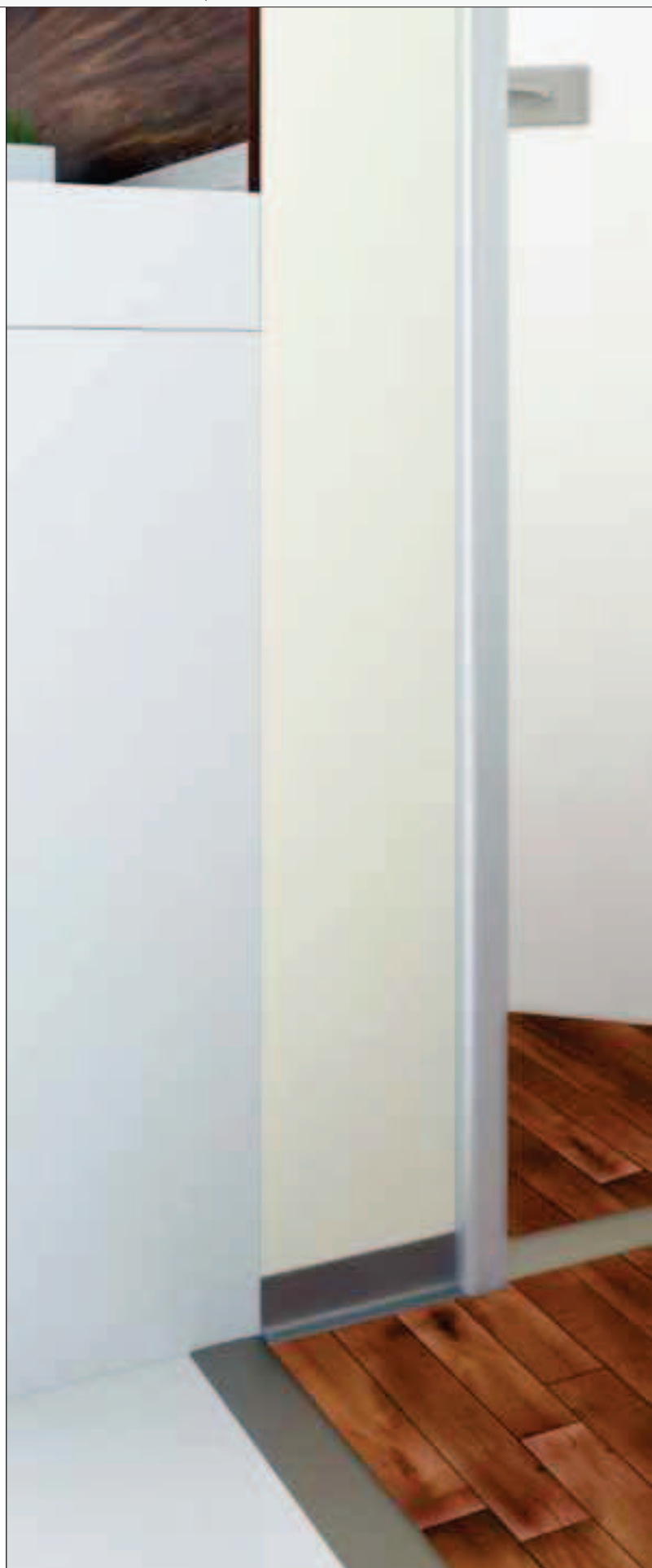

АЛЮМИНИЕВЫЕ ЦОКОЛЬНЫЕ
ПРОФИЛЯ



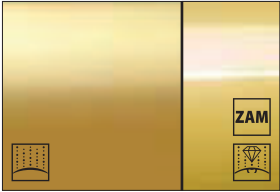
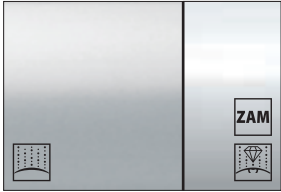
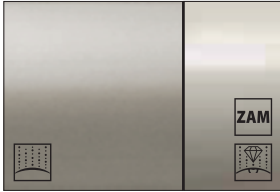

ALUMINIUM ANODOWANE

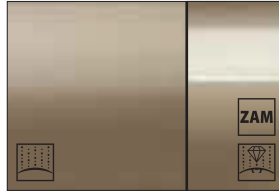
ANODISED ALUMINIUM | ALUMINIUM ELOXIERT | АНОДИРОВАННЫЙ АЛЮМИНИЙ

				
złoto - 00	srebro - 01	inox - 71	inox szczotkowany - 07	szampan - 02
gold Gold золото	silver Silber серебро	inox Inox инокс	brushed inox Gebürstet Inox щеткой инокс	champagne Champagne шампанское
				
brąz - 03	oliwka - 04	czarny - 005		
bronze Braun коричневый	olive Olive оливка	black Schwarz черный		

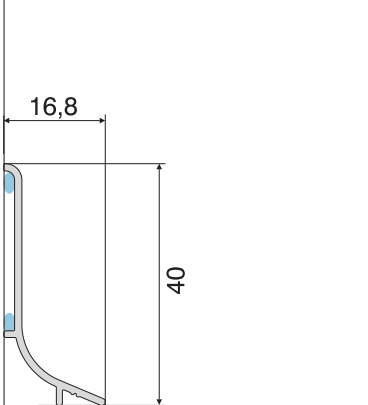
плинтус самоклеющийся	Sockelprofil SELBSTKLEBEND	Skirting board SELF-ADHESIVE
		
DŁUGOŚĆ [m] Length Länge Длина	2,7	

Listwa cokołowa aluminiowa
SAMOPRZYLEPNA

Q63

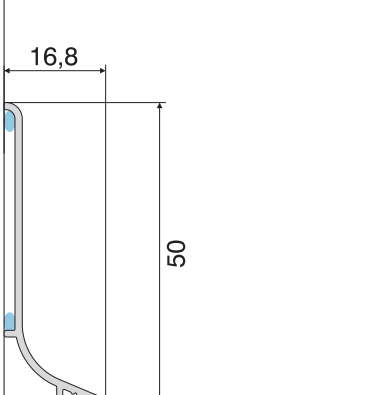

AI   

плинтус самоклеющийся	Sockelprofil SELBSTKLEBEND	Skirting board SELF-ADHESIVE
		
DŁUGOŚĆ [m] Length Länge Длина	2,7	

Listwa cokołowa aluminiowa
SAMOPRZYLEPNA

Q64



AI   

ALUMINIOWE I MOSIĘŻNE LISTWY DO GLAZURY I TERAKOTY



Łazienki to pomieszczenia, w których listwy oraz dodatki nierzadko decydują o ostatecznym wyglądzie i charakterze wnętrza. W ostatnich latach dużą popularnością cieszą się eleganckie półki i podesty, wykonane z płytek ceramicznych, podkreślone dodatkowo przez mosiężne czy aluminiowe profile. Oprócz funkcji czysto dekoracyjnej, profile te perfekcyjnie wypełniają także bardziej prozaiczne zadania: ukrywają nierówności podłoża lub płytek oraz chronią przez uszkodzeniem wewnętrzne i zewnętrzne naroża z glazury.

Effect Impresja to listwy przeznaczone do eleganckiego, a równocześnie praktycznego zabezpieczenia brzegów powierzchni, wyłożonych płytkami ceramicznymi. Bogata oferta długości i kolorystyki tych profili, w pełni odpowiada aktualnym trendom, obowiązującym na rynku. Elementy dedykowane do wnętrz stylowych, dostępne są także w wersji mosiężnej.

Bathrooms are places whose final look and character very often depends on strips and ornaments. Over the past few years, elegant shelves and podiums made of ceramic tiles and additionally highlighted by brass or aluminium profiles gained much popularity. Apart from decorative advantages, these profiles are perfect for hiding uneven floorings and tiles and for protecting inside and outside tile angles against damage.

Effect Impresja are strips designed for elegant and practical protection of ceramic tiles edgings. Wide variety of profiles' lengths and colours is in accordance with modern market trends. Elements dedicated for stylish interiors are also available in brass.

ALUMINIUM AND BRASS
PROFILES FOR TILES



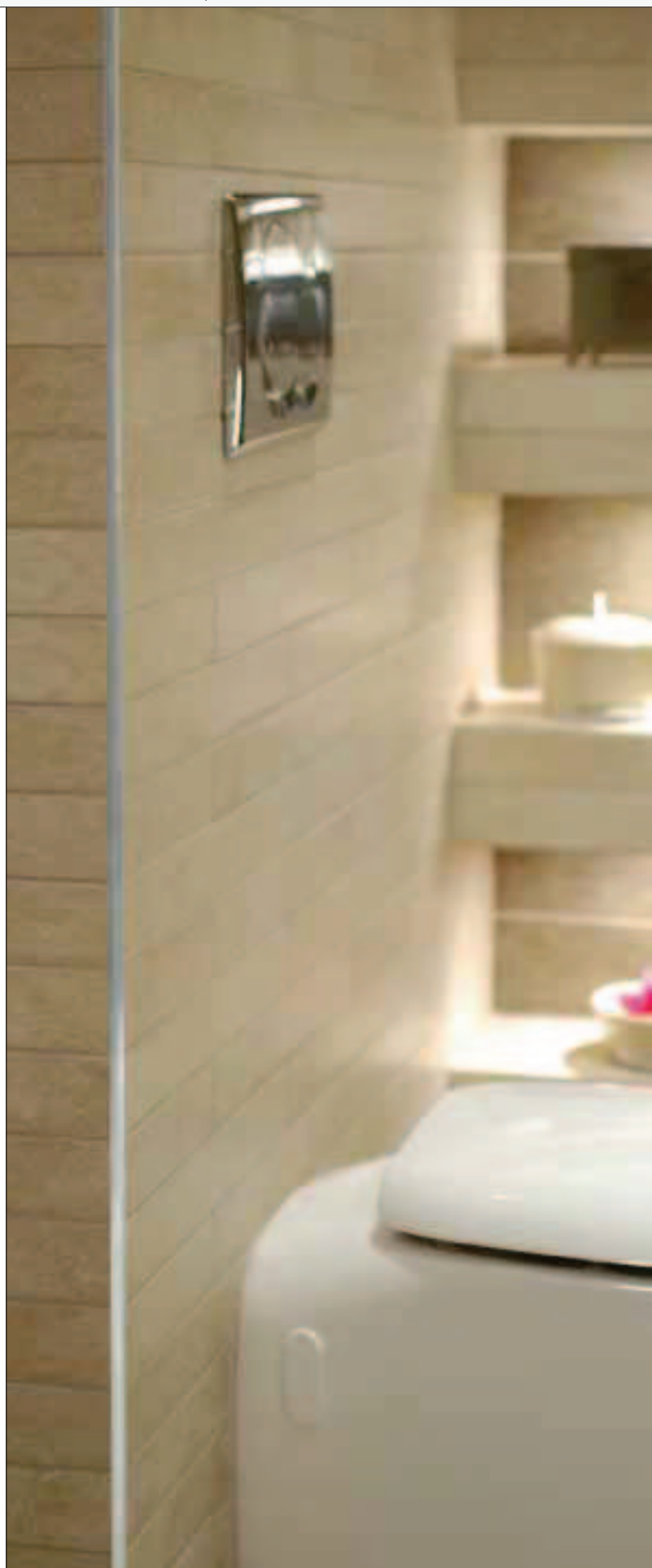

FLIESENPROFILE AUS ALUMINIUM
UND MESSING

АЛЮМИНИЕВЫЕ И ЛАТУННЫЕ
ПРОФИЛИ ДЛЯ КАФЕЛЬНОЙ
ПЛИТКИ



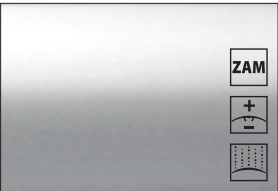
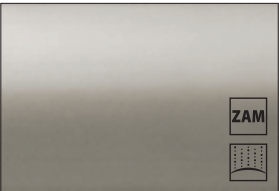

ALUMINIUM ANODOWANE

ANODISED ALUMINIUM | ALUMINIUM ELOXIERT | АНОДИРОВАННЫЙ АЛЮМИНИЙ

				
złoto - 00	srebro - 01	srebro - elektropoler - E01	inox - 71	inox szczotkowany - 07
gold Gold золото	silver Silber серебро	silver electropolished Silber mit elektro-poliert серебро электрополированная	inox Inox иннокс	brushed inox Gebürstet Inox щеткой иннокс

ALUMINIUM NATURALNE

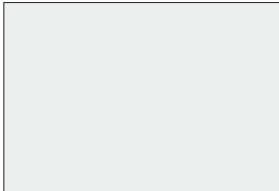
NATURAL ALUMINIUM | NATUR ALUMINIUM | НАТУРАЛЬНЫЙ АЛЮМИНИЙ

	
naturalne - 90	polerowane - 91
natural Natur натуральный	polished Poliert, Glänzend полерованный

MOSIĄDZ

BRASS | MESSING | ЛАТУНЬ

mosiądz - 05
brass Messing латунь



A50

Listwa krawędziowa

Edge strip | Randleiste | Профиль угловой

KOLOR | Colour | Farbe | Цвет | 90 | 00 | 01 | 05

8

DŁUGOŚĆ [m] | Length | Länge | Длина | 1,0 | 2,0 | 2,5 | 3,0



A51

Listwa krawędziowa

Edge strip | Randleiste | Профиль угловой

KOLOR | Colour | Farbe | Цвет | 90 | 00 | 01 | 05

10

DŁUGOŚĆ [m] | Length | Länge | Длина | 1,0 | 2,0 | 2,5 | 3,0

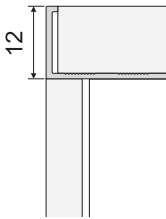
Профиль угловой	Randleiste	Edge strip		
KOLOR Colour Farbe Цвет	90	00	01	05
				
DŁUGOŚĆ [m] Length Länge Длина	1,0	2,0	2,5	3,0

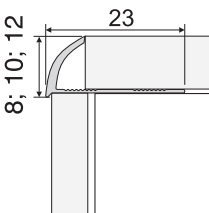

Профиль угловой овалный	Randleiste, oval	Oval edge strip			
KOLOR Colour Farbe Цвет	90	91	00	01	05
					
DŁUGOŚĆ [m] Length Länge Длина	1,0	2,0	2,5	3,0	

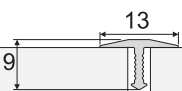

Профиль для швов	Fugenprofil	Joint profil			
KOLOR Colour Farbe Цвет	90	91	00	01	05
					



* - dostępny na zamówienie w okleinach - długość 2,5m - kolorystyka Effect Standard (str. 10-11)
available to order in veneer - length 2,5m - coloring of Effect Standard, p.10-11
Verfügbar auf Bestellung in Furnier - Länge 2,5m - siehe effect Standard (Seite 10-11)
Доступна в ламинатах по заказу - длина 2,5м - цветовая гамма effect Standard, стр.10-11

DŁUGOŚĆ [m] Length Länge Длина	1,0	2,0	2,5	3,0
---------------------------------------	-----	-----	-----	-----

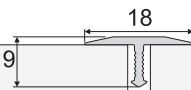
Профиль для швов	Fugenprofil	Joint profil			
KOLOR Colour Farbe Цвет	90	91	00	01	05
					



* - dostępny na zamówienie w okleinach - długość 2,5m - kolorystyka Effect Standard (str. 10-11)
available to order in veneer - length 2,5m - coloring of Effect Standard, p.10-11
Verfügbar auf Bestellung in Furnier - Länge 2,5m - siehe effect Standard (Seite 10-11)
Доступна в ламинатах по заказу - длина 2,5м - цветовая гамма effect Standard, стр.10-11

DŁUGOŚĆ [m] Length Länge Длина	1,0	2,0	2,5	3,0
---------------------------------------	-----	-----	-----	-----

A56* Profil fugowy







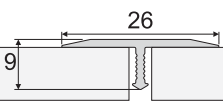

Joint profil	Fugenprofil	Профиль для швов					
KOLOR Colour Farbe Цвет <table border="1"> <tr> <td>90</td> <td>91</td> <td>00</td> <td>01</td> <td>05</td> </tr> </table>			90	91	00	01	05
90	91	00	01	05			
							
* - dostępny na zamówienie w okleinach - długość 2,5m - kolorystyka Effect Standard (str. 10-11) available to order in veneer - length 2,5m - coloring of Effect Standard, p.10-11 Verfügbar auf Bestellung in Furnier - Länge 2,5m - siehe effect Standard (Seite 10-11) Доступна в ламинатах по заказу - длина 2,5м - цветовая гамма effect Standard, стр.10-11							
DŁUGOŚĆ [m] Length Länge Длина <table border="1"> <tr> <td>1,0</td> <td>2,0</td> <td>2,5</td> <td>3,0</td> </tr> </table>			1,0	2,0	2,5	3,0	
1,0	2,0	2,5	3,0				

A57 Listwa łączeniowa płaska







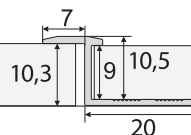

Flat joining strip	Übergangsleiste, flach	Профиль соединительный плоский				
KOLOR Colour Farbe Цвет <table border="1"> <tr> <td>90</td> <td>00</td> <td>01</td> <td>05</td> </tr> </table>			90	00	01	05
90	00	01	05			
						
DŁUGOŚĆ [m] Length Länge Длина <table border="1"> <tr> <td>1,0</td> <td>2,0</td> <td>2,5</td> <td>3,0</td> </tr> </table>			1,0	2,0	2,5	3,0
1,0	2,0	2,5	3,0			

A58 Listwa schodowa





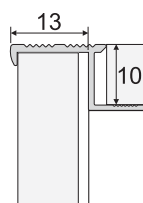

Stair strip	Stufenleiste	профиль для ступеньки				
KOLOR Colour Farbe Цвет <table border="1"> <tr> <td>90</td> <td>00</td> <td>01</td> <td>05</td> </tr> </table>			90	00	01	05
90	00	01	05			
						
DŁUGOŚĆ [m] Length Länge Длина <table border="1"> <tr> <td>1,0</td> <td>2,0</td> <td>2,5</td> <td>3,0</td> </tr> </table>			1,0	2,0	2,5	3,0
1,0	2,0	2,5	3,0			

A59 Listwa najazdowa





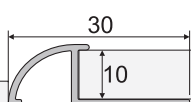

Approaching strip	Ausgleichsleiste	Профиль наклонный				
KOLOR Colour Farbe Цвет <table border="1"> <tr> <td>90</td> <td>00</td> <td>01</td> <td>05</td> </tr> </table>			90	00	01	05
90	00	01	05			
						
DŁUGOŚĆ [m] Length Länge Длина <table border="1"> <tr> <td>1,0</td> <td>2,0</td> <td>2,5</td> <td>3,0</td> </tr> </table>			1,0	2,0	2,5	3,0
1,0	2,0	2,5	3,0			

полукруглый профиль для ступенек | Stufenprofil | Half-rounded stair strip

KOLOR
Colour | Farbe | Цвет | 90 | 00 | 01

DŁUGOŚĆ [m]
Length | Länge | Длина | 1,0 | 2,0 | 2,5 | 3,0

Profil schodowy półokrągły **A80**

AI [] + []

овальный профиль для ступенек | Stufenprofil | Oval stair strip

KOLOR
Colour | Farbe | Цвет | 90 | 00 | 01

DŁUGOŚĆ [m]
Length | Länge | Длина | 1,0 | 2,0 | 2,5 | 3,0

Profil schodowy owalny **A81**

AI []

профил для глазура (кафеля) с окончаниями внешними и внутренними | Fliesenprofil mit Innen- und Außenecken | tile profile with external and internal corner elements

KOLOR
Colour | Farbe | Цвет | 90 | 91 | 00 | 01 | 02 | 81 | 89 | 88 | 71

A	B	C
7	26	6
9	28	8
11	30	10
13,6	32,5	12,5

DŁUGOŚĆ [m]
Length | Länge | Длина | 2,5

Listwa do glazury z zakończeniami zewnętrznymi i wewnętrznymi **A83**

AI [] [] [] + [] ZAM

Наружные и внутренние наконечники к профилю A83 | Innen und außen Abschluss passend zur Leiste A83 | External and internal corner elements

KOLOR
Colour | Farbe | Цвет | RAL

Zakończenia zewnętrzne i wewnętrzne do listwy A83 **A83**

ZAM



A95

Listwa najazdowa



Approaching strip	Ausgleichsleiste	Профиль наклонный
KOLOR Colour Farbe Цвет		05
DŁUGOŚĆ [m] Length Länge Длина		1,0 2,0 2,5 3,0

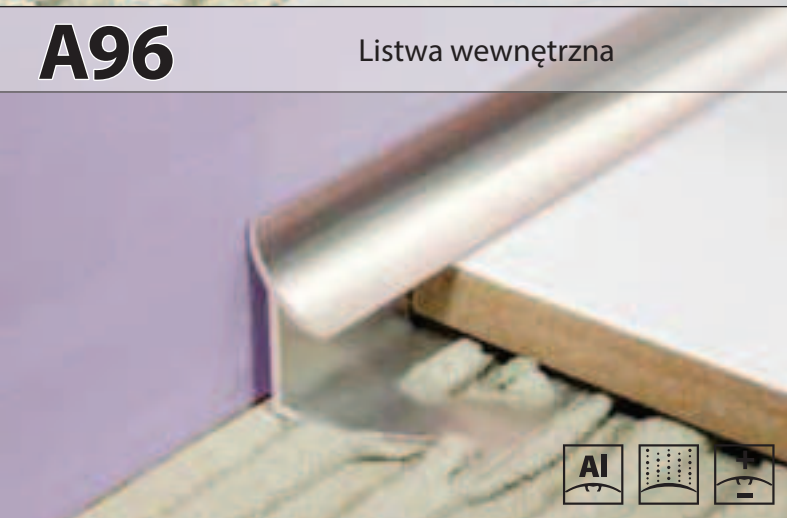

A96

Listwa wewnętrzna



Inner strip	Innenleiste	внутренний
KOLOR Colour Farbe Цвет		90 00 01
DŁUGOŚĆ [m] Length Länge Длина		1,0 2,0 2,5 3,0

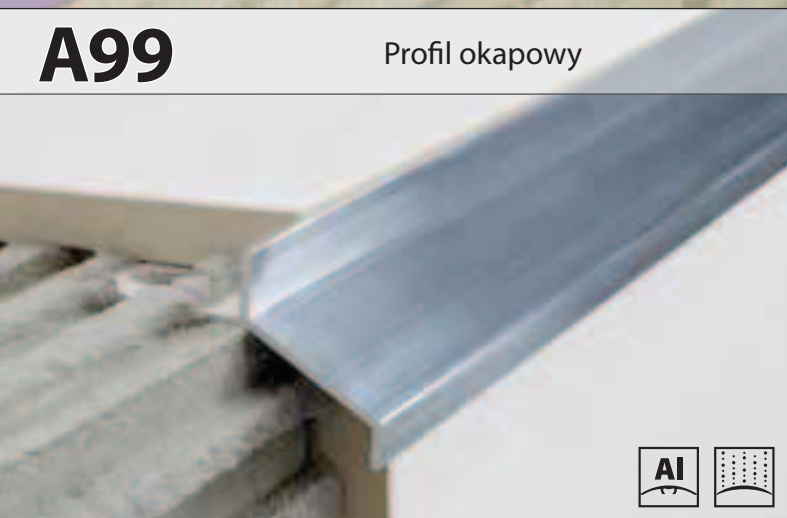

A99

Profil okapowy



Hood profile	Wetterschenkel	водоотливной профиль
KOLOR Colour Farbe Цвет		90 00 01
DŁUGOŚĆ [m] Length Länge Длина		2,5



A82

Listwa dekoracyjna RIO



Decorative strip RIO	Zierleiste RIO	Декоративный профиль RIO
KOLOR Colour Farbe Цвет		91 00 01 71 07 02 03
DŁUGOŚĆ [m] Length Länge Длина		2,7

Декоративный профиль RIO	Zierleiste RIO	Decorative strip RIO
<p>KOLOR Colour Farbe Цвет</p> <p>91 00 01 71 07 02 03</p>		
<p>DŁUGOŚĆ [m] Length Länge Длина</p> <p>2,7</p>		

Listwa dekoracyjna RIO **A84**

AI

Профиль ступенчатый для керамической плитки	Stufenprofil zu der Keramikfliesen	Stair profile for tiles
<p>DŁUGOŚĆ [m] Length Länge Длина</p> <p>1,0 2,0 2,5 3,0</p>		

Profil schodowy do glazury **A85**

AI

Профиль угловой с резиной для ступеней	Eckleiste für Treppen mit Gummiband	Stair profile with anti-sliding lining rubber
<p>KOLOR Colour Farbe Цвет</p> <p>90</p>		
<p>DŁUGOŚĆ [m] Length Länge Длина</p> <p>2,5</p>		

Listwa narożna schodowa z gumą **A97+A98**

AI

KOLORY GUMY A98

RUBBER COLOURS | FARBEN | ЦВЕТА РЕЗИНЫ

czarny - 88	szary - 89	brąz - 86
black	grey	brown
Schwarz	Grau	Braun
черный	серый	коричневый

LISTWY WYKOŃCZENIOWE GIĘTE



Gięte listwy wykończeniowe oferują wyjątkowo szerokie możliwości kreacji przestrzeni. Ich praktyczne zadanie polega na estetycznym przysłonięciu szczelin pomiędzy podłogami, które nie tylko są wykonane z różnych materiałów, ale także posiadają nietypowe kształty (np. łuki, koła, półkola). W ten oryginalny, pełen niestandardowych form sposób, łączone są najczęściej podłogi drewnopodobne, wykładziny lub parkiety, z płytkami ceramicznymi lub kamieniami naturalnymi. Profile gięte, dzięki swej elastyczności, znajdują zastosowanie nie tylko we wnętrzach nowoczesnych, ale również w pomieszczeniach urządzonych w stylu klasycznym czy retro.

Effect Boa – to profile aluminiowe i z tworzywa PVC, które są przeznaczone do łączenia różnych powierzchni podłóg, o nieregularnych, fantazyjnych kształtach. Dzięki swym właściwościom gięcia, doskonale dostosowują się do obecnych trendów aranżacji wnętrz.

Flexible finishing strips offer extremely wide range of creative possibilities. Their practical task is to cover gaps between floors (made of various materials and having atypical shapes e.g. arcs, circles, semicircles) in elegant way. In this original way, wooden-like floorings, covers and parquet floorings are usually joined with ceramic tiles and natural stones. Thanks to their flexibility, these strips can be used not only in modern interiors but also in classic and retro ones.

Effect Boa – these are aluminium and PVC profiles which are designed for joining various flooring with irregular and original shapes. Thanks to their flexibility strips adjust perfectly to modern trends of interior design.

BENDABLE FINISHING STRIPS

BIEGELEISTEN

ОТДЕЛОЧНЫЕ ГНУТЫЕ ПРОФИЛИ

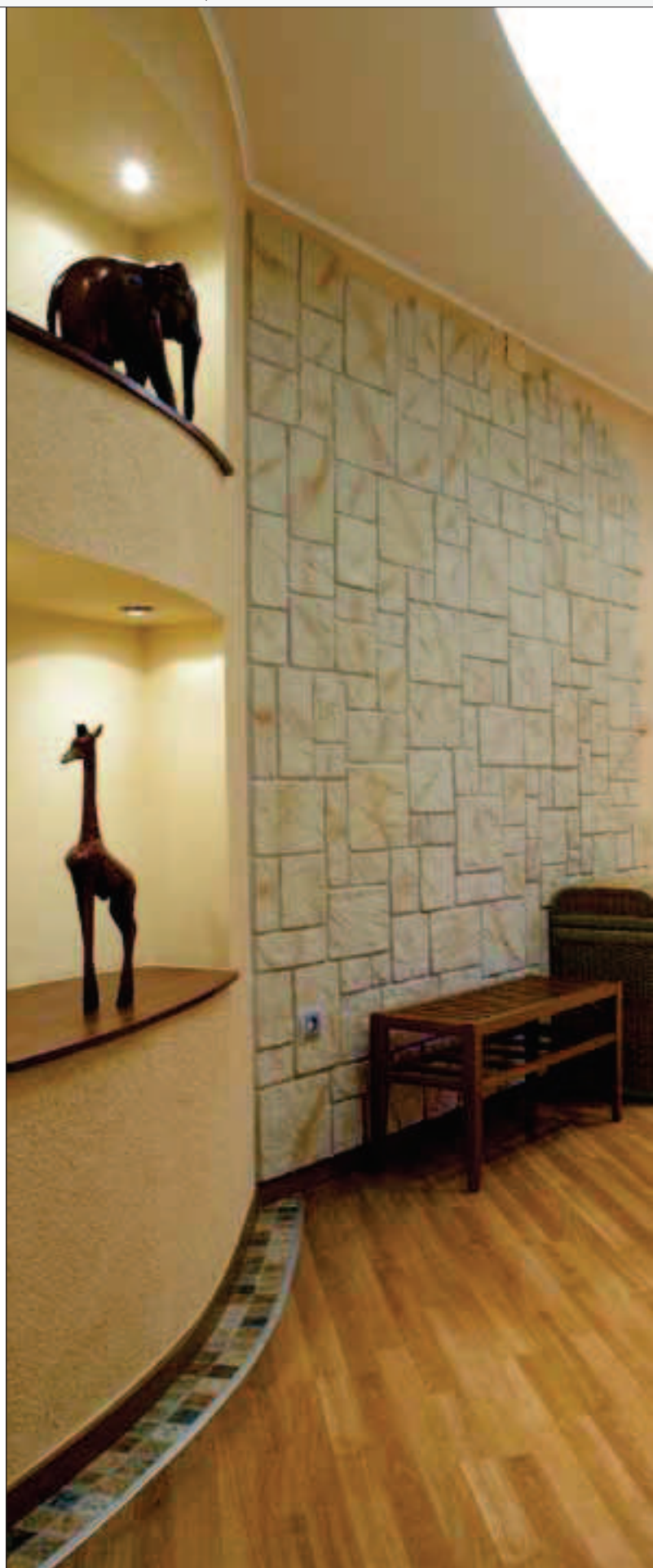

ALUMINIUM ANODOWANE

ANODISED ALUMINIUM | ALUMINIUM ELOXIERT | АНОДИРОВАННЫЙ АЛЮМИНИЙ



ALUMINIUM NATURALNE

NATURAL ALUMINIUM | NATUR ALUMINIUM | НАТУРАЛЬНЫЙ АЛЮМИНИЙ

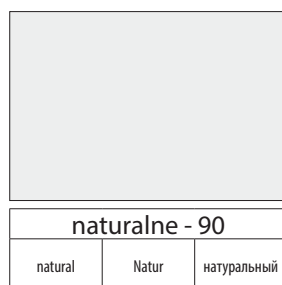

ALUMINIUM OKLEINOWANE

VENEERED ALUMINIUM | ALUMINIUM UMMANTELT | ЛАМИНИРОВАННЫЙ АЛЮМИНИЙ



ALUMINIUM OKLEINOWANE

VENEERED ALUMINIUM | ALUMINIUM UMMANTELT | ЛАМИНИРОВАННЫЙ АЛЮМИНИЙ



wiąz - 34	mahoń - 24	mahoń Togo - 2402	afrezja - 33	orzech Chile - 2701
elm Ulme вяз	mahogany Mahagoni красное дерево	Togo mahogany Mahagoni Togo красное дерево Togo	afrezy Afrezy афрезия	Chile nut Nussbaum Chile орех Чили
teak indyjski - 4500	heban afrykański - 4501	wenge Kongo - 4201	dąb bielony - 20901	dąb Mocca - 20902
Indian teak Indischer Teak тик Индийский	African ebony Afrikanischer Heban черное фриканское Дерево	Congo wenge Wenge Kongo венге Конго	white oak Eiche gebleicht беленный дуб	Mocca oak Eiche Mocca дуб Моща
dąb antyczny - 20903	dąb arctic - 20904	dąb bursztynowy - 20905	dąb koniakowy - 20906	dąb piaskowy - 20907
antique oak Eiche antik дуб античный	arctic oak Eiche Arctic дуб арктиц	Amber oak Eiche Bernstein янтарный дуб	Cognac oak Eiche Cognac коняковый дуб	Sandy oak Eiche Sand песочный дуб
dąb piwny - 20908	dąb zamkowy - 20910	merbau - 20944		
Bery oak Eiche Hellbraun пивной дуб	Castle oak Schloss Eiche замочный дуб	merbau Merbau мербау		

MOSIĄDZ

BRASS | MESSING | ЛАТУНЬ

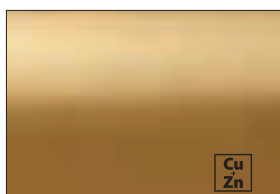

mosiądz - 05		
brass	Messing	латунь

S53 Profil narożny gięty



AI   

Bendable corner profile | Eckprofil gebogen | Профиль угловой изогнутый

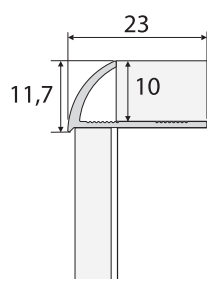

DŁUGOŚĆ [m] | Length | Länge | Длина | 2,5

S57 Profil łączeniowy gięty



AI   



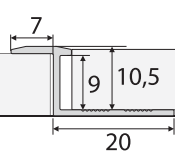

Bendable joining profile | Verbindungsprofil biegsam | соединительный гнутый профиль

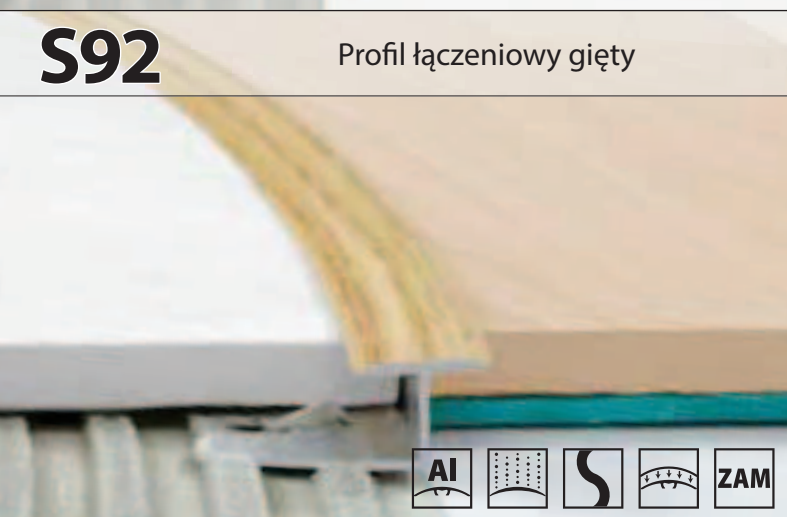

DŁUGOŚĆ [m] | Length | Länge | Длина | 2,5

S92 Profil łączeniowy gięty



AI     **ZAM**

Flat joining strip | Verbindungsprofil biegsam | соединительный гнутый профиль

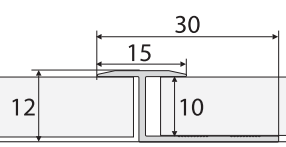

DŁUGOŚĆ [m] | Length | Länge | Длина | 2,5

S93 Profil zakończeniowy gięty



AI     **ZAM**

Bendable finishing profile | Abschlussprofil biegsam | окантовочный гнутый профиль

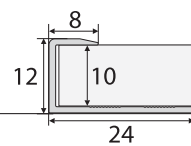

DŁUGOŚĆ [m] | Length | Länge | Длина | 2,5

Профиль угловой
изогнутый

Eckprofil gebogen

Bendable corner profile

Profil narożny gięty

A94



DŁUGOŚĆ [m]
Length | Länge | Длина

3,0



LISTWA A100 BIG EFFECT

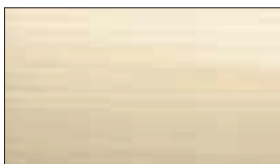

klon - 25
maple | Ahorn | клен



buk - 08
beech | Buche | бук



dąb - 09
oak | Eiche | дуб



złoto - 00
gold | Gold | золото

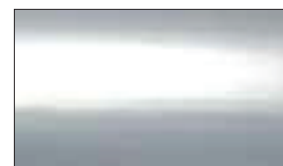

srebro - 01
silver | Silber | серебро



wiśnia - 22
cherry | Kirsch-baum | вишня



mahoń - 24
mahogany | Mahagoni | красное дерево

Профиль выравнивающий
BIG EFFECT ПВХ

Biegbare Profile
BIG EFFECT PVC

Dilatation slat
BIG EFFECT PVC

Listwa dylatacyjna
BIG-EFFECT PVC

A100

DŁUGOŚĆ [m]
Length | Länge | Длина

3,0

6,0

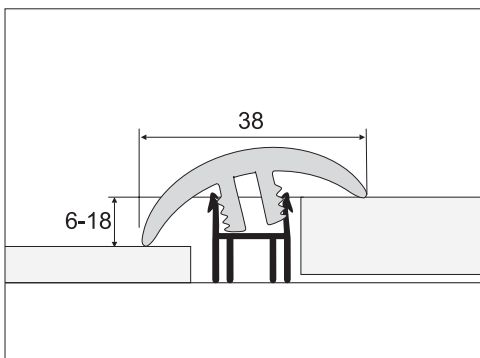
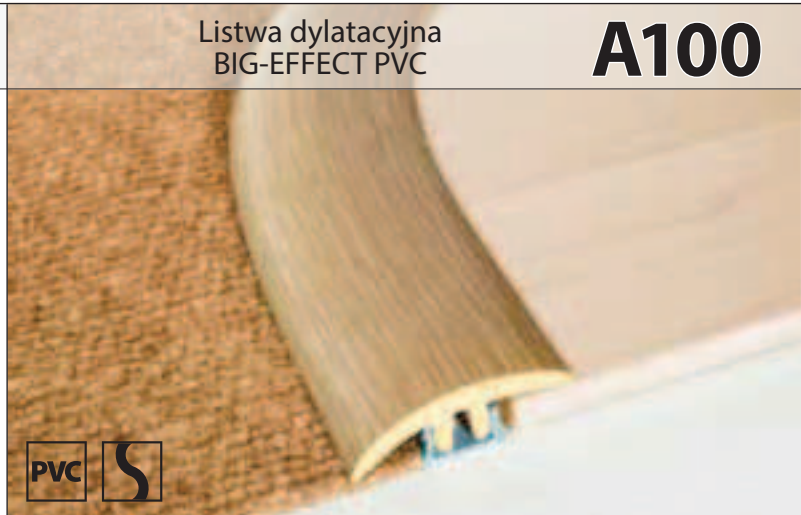

listwa bazowa wysoka
High base profile | Basisprofil hoch | Базовый профиль высокий

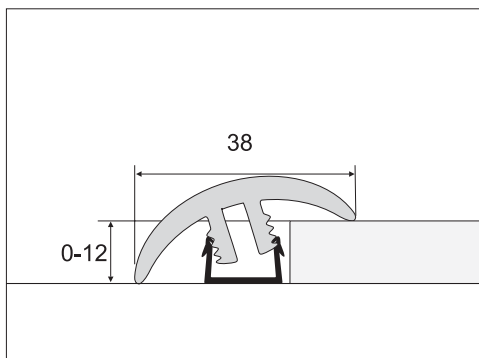

listwa bazowa niska
Low base profile | Basisprofil niedrig | Базовый профиль низкий

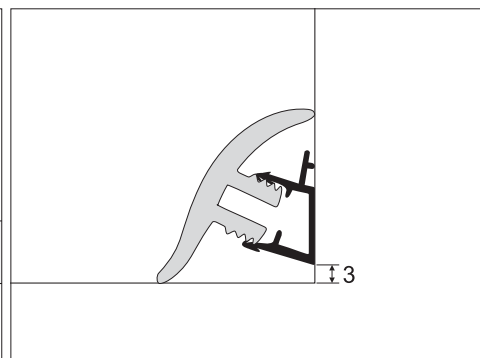

listwa bazowa skośna
Slanting base profile | Basisprofil schräg | Базовый профиль скошенный

LISTWA PRZYPODŁOGOWA PVC



Listwy przypodłogowe to element wyposażenia, który subtelnie podkreśla charakter i styl wnętrza, a zarazem stanowi efektowne wykończenie podłogi. Najważniejsze, bardzo praktyczne zadania listew przypodłogowych polegają na przystąpieniu dylatacji oraz ukryciu przewodów elektrycznych czy telefonicznych, a także na ochronie ściany tuż przy podłodze.

Effect Queen to listwa cokołowa, zwieńczająca podłogę z paneli lub naturalnego drewna. Jest wykonana z wysokiej jakości PVC, wyróżnia się nie tylko unikalną konstrukcją, ale również doskonałymi właściwościami i parametrami użytkowymi oraz niepowtarzalną kolorystyką. Szeroki, dwudzielny kanał na przewody sprawia, że przewyższa funkcjonalnością wszystkie inne, dostępne na rynku produkty. Listwa maskująca zapewnia nie tylko komfortowy montaż, ale także wygodny serwis użytkowanego profilu. Elementy z kolekcji Queen doskonale dopasowują się do nierówności ścian i podłóg, posiadają dużą elastyczność, a jednocześnie cechuje je wyjątkowa trwałość montażu, dzięki specjalnej, opatentowanej konstrukcji zatrząsków.

Effect Queen to kompleksowa oferta produktów wykończeniowych do podłóg drewnianych oraz drewnopodobnych.

Baseboards are the elements that highlight the style and character of a given interior in a subtle way. They also offer attractive flooring finish. The most important and very practical tasks of baseboards are: covering settlement joints, covering electric and telephone wires as well as protecting walls right next to the floor.

Effect Queen is a skirting board that finishes panel or wooden flooring. It is made of high quality PVC and it stands out not only thanks to unique structure but also due to perfect operational characteristics and parameters. Wide, two-chamber spacing for cables makes this skirting board the most functional product on the market. Covering board ensures easy mounting as well as simple service of the used profile. Elements from Queen collection perfectly adjust to uneven walls and floors because they are very flexible. At the same time, they are characterized by exceptional mounting durability thanks to special, patented catches.

Effect Queen is a wide variety of finishing products for wooden and wooden-like floorings.

PVC SKIRTING BOARD

SOCKELKUNSTOFFLEISTEN

ПЛИНТУС ПВХ



**PRODUKT POSIADA REKOMENDACJĘ TECHNICZNĄ
 ITB RT ITB 1262/2013**

THE PRODUCT HAS TECHNICAL RECOMMENDATION ITB RT ITB 1262/2013

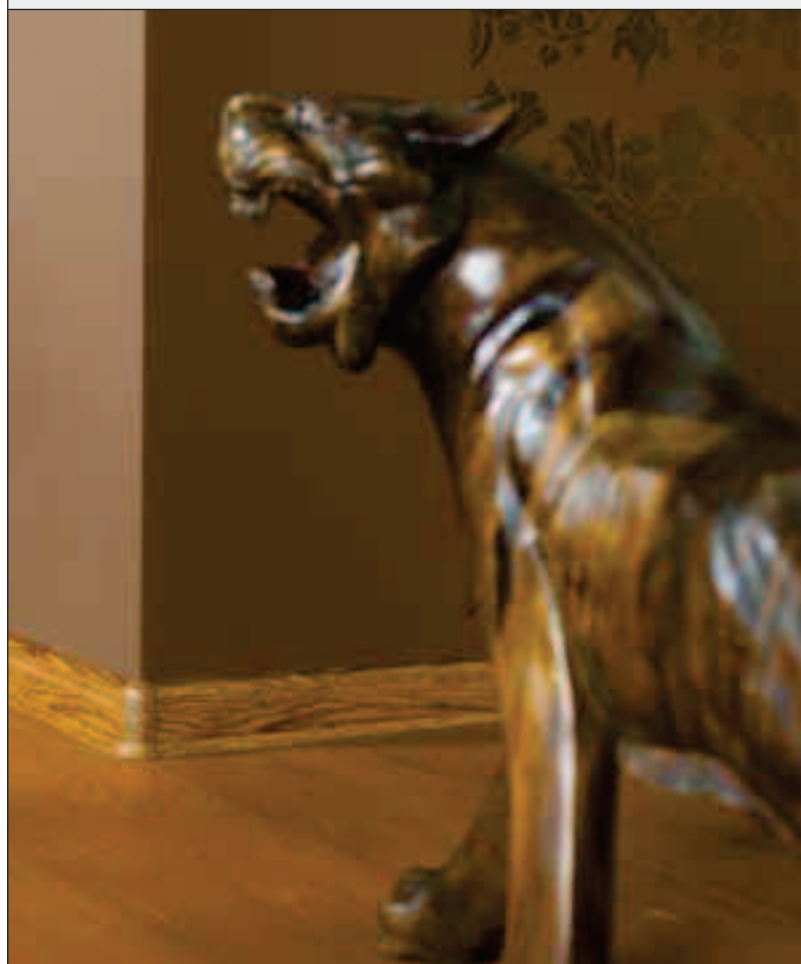

KOLORYSTYKA

COLOURING | FARBE | ЦВЕТ

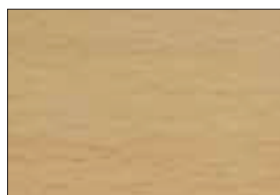

buk książęcy - 0805

Palace beech Kaiser Buche бук Княжеский



buk Montana - 0803

Montana beech Buche Montana бук Montana



buk flander - 0804

flader beech Buche Flander бук флейдер



dąb sierra - 0904

sierra oak Eiche Sierra дуб sierra



dąb Alaska - 0910

Alaska oak Eiche Alaska дуб Аляска

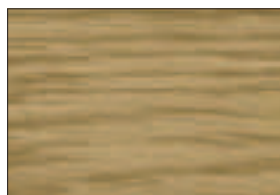

dąb dworkowy - 0903

manor oak Eiche Landhaus усадебный дуб



dąb polski - 0908

Polish oak Eiche Polnisch дуб польский



dąb country - 0906

Country oak Eiche Country дуб кантри



dąb rustykalny - 0902

rustic oak Eiche Rustical дуб рустикальный



czereśnia - 4000

gean Kirsche черешня



jesion Bergen - 4102

Bergen ash Esche Bergen ясень Берген

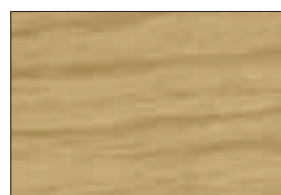

hikora Kalifornia - 3201

California hickory Hikora California хикора Калифорния



hikora ciemna - 3202

dark hickory Hikora dunkel хикора темный

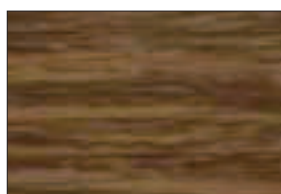

teak ciemny - 4501

dark teak Teak dunkel тик темный

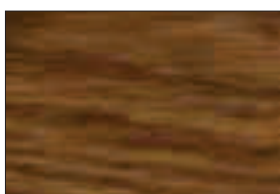

mahoń country - 0241

country mahogany Mahagoni Country красное дерево кантри

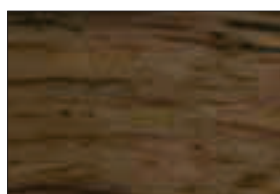

wenge Kongo - 4201

Congo wenge Wenge Kongo венге Конго



wenge - 4200

wenge Wenge венге

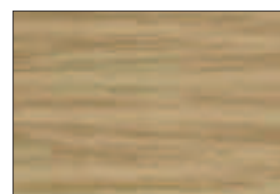

dąb - 40900

oak Eiche дуб

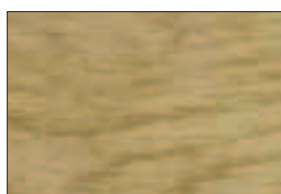

dąb jasny - 42900

light oak Eiche hell светлый дуб



dąb Kalifornia - 40912

California oak Eiche California дуб Калифорния



dąb Montana - 40911

Montana oak Eiche Montana дуб Montana



dąb złocisty - 40909

golden oak Eiche Gold дуб золотистый



dąb górski - 40913

mountain oak Eiche Berg горный дуб



mahoń - 40240

mahogany Mahagoni красное дерево



dąb antyczny - 20903

antique oak Eiche antik дуб античный

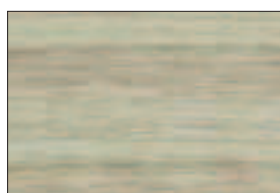

dąb Mocca - 20902

mocca oak Eiche Mocca дуб моща



dąb arctic - 20904

arctic oak Eiche Arctic дуб арктиц



dąb bursztynowy - 20905

Amber oak Eiche Bernstein янтарный дуб



dąb koniakowy - 20906

Cognac oak Eiche Cognac коньяковый дуб



dąb piaskowy - 20907

Sandy oak Eiche Sand песочный дуб



dąb piwny - 20908

Bery oak Eiche Hellbraun пивной дуб



merbau - 20944

merbau Merbau мербау

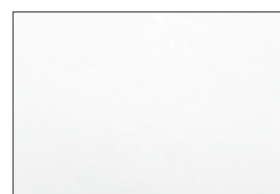

biały - 48000

white Weiß белый

профиль пакуется по 30 шт.

Verpackungseinheit – 30 Stck.

Packed in 30 pcs.

Listwa pakowana po 30 szt.

QUEEN

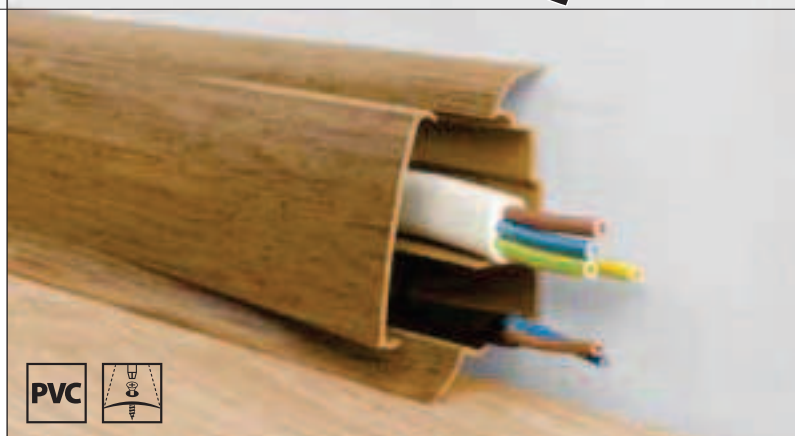
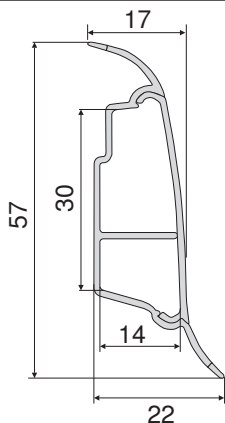

внутренний уголок

Innenecke

internal corner profile

Narożnik wewnętrzny

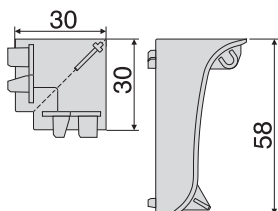

Pakowany po 2 szt.
Packed in 2 pcs.
Verpackungseinheit 2 Stck.
Пакуется по 2 шт.



монтажный элемент наружного уголка

Montage Element des Aussenwinkelprofiles

mounting component of the external corner

Element montażowy narożnika zewnętrznego

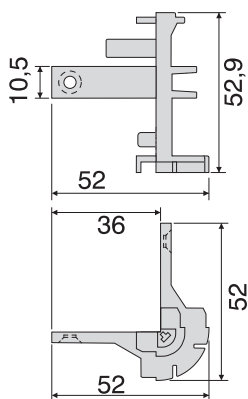

Narożniki i elementy montażowe pakowane razem po 2szt.
Angle bar with mounted elements are packed together in 2 pcs.
Ecken und Montageelemente-Verpackung 2 Stück.
Наружные уголки и монтажные элементы упакованные вместе по 2 шт.



наружный уголок

Aussenecke

external corner profile

Narożnik zewnętrzny

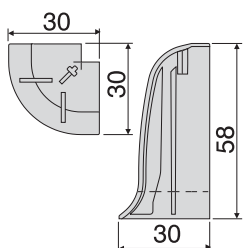

Narożniki i elementy montażowe pakowane razem po 2szt.
Angle bar with mounted elements are packed together in 2 pcs.
Ecken und Montageelemente-Verpackung 2 Stück.
Наружные уголки и монтажные элементы упакованные вместе по 2 шт.



Zakończenie prawe lub lewe

right or left ending profile

Endstück links oder rechts

окончание правое или левое



Pakowane po 2 szt.
 (kpl. zakończenie prawe i lewe)
 Packed in 2 pcs.
 (right and left ending profile)
 Verpackt je 2 Stck. oder Sätze
 (Abschlusskappe links oder rechts)
 Пакується по 2 шт.
 (комплект окончании правое и левое)

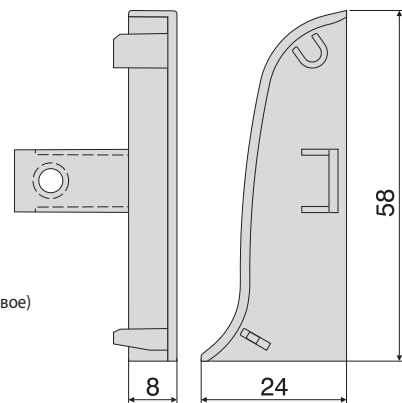

Łącznik

joining profile

Zwischenstueck

соединитель



Pakowane po 2 szt.
 Packed in 2 pcs.
 Verpackungseinheit 2 Stck.
 Пакується по 2 шт.

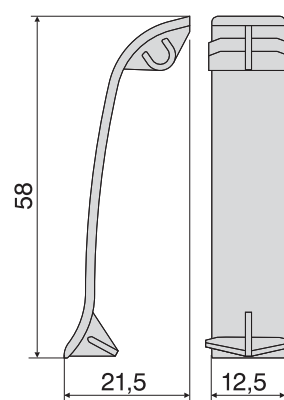

1

MONTAŻ

Installation

Montage

Монтаж



Montaż listew rozpoczynamy od docięcia listew na odpowiednią długość. Listwy tnijemy używając do tego piły o drobnych zębach (najlepiej piły do metalu) i skrzynki uciosowej. Następnie montujemy narożnik wewnętrzny.
 First cut of a strip to the required length. Strips should be cut using a saw with small teeth (preferably metal saws) and miter box. Then mount the internal corner.

2

MONTAŻ

Installation

Montage

Монтаж



Otwieramy listwę i przykładamy do ściany. Jeśli wszystko pasuje nawiercamy otwory na kołki szybkiego montażu. Do przykręcenia listew zaleca się stosować kołki o średnicy \varnothing 4-5mm. Otwory wiercimy w odległości nie większej niż 60 cm.

Open the strip and attach to the wall. If everything fits, drill holes for quick mounting pins. It is recommended to use pins with a diameter of \varnothing 4-5mm. Holes should be drilled at a distance not more than 60 cm.

Монтаж

Montage

Installation

MONTAŻ

3

Montujemy element montażowy narożnika zewnętrznego. Nawiercamy wstępnie listwę przez otwór w łapce elementu montażowego. Następnie wiercimy pod kołek montażowy samą listwę i montujemy kołek w ścianie. Przykładamy element montażowy i przez otwory w elemencie montażowym przykręcamy go do ściany.

Assemble the mounting component of the external corner. Pre-drill the hole in the strip through the slot in the assembly element. Then drill the hole for the mounting pin in the strip and assemble a pin in the wall. Attach the assembly element and screw it to the wall through the holes.



Монтаж

Montage

Installation

MONTAŻ

4

Wewnątrz listwy w kanałach możemy ułożyć przewody elektryczne, telefoniczne, komputerowe itp. Listwy Queen posiadają dwa odrębne kanały, ułatwiające rozmieszczenie przewodów.

Inside the strip channels, you can lay the electrical, telephone or computer wires etc. Queen strips have two separate channels, to facilitate the cables laying.



Монтаж

Montage

Installation

MONTAŻ

5

W celu zamontowania zakończenia postępujemy podobnie jak przy montażu narożnika zewnętrznego. Wstępnie nawiercamy listwę przez otwór w łapce, a następnie wiercimy pod kołek montażowy samą listwę. Montujemy kołek w ścianie i przez otwór w łapce przykręcamy element do ściany.

In order to install the ending element, proceed similar to the assembly of the outside corner. Pre-drill hole in the strip by the slot, and then drill the hole for the pin in the strip. Mount the pin in the wall and screw the element to the wall.

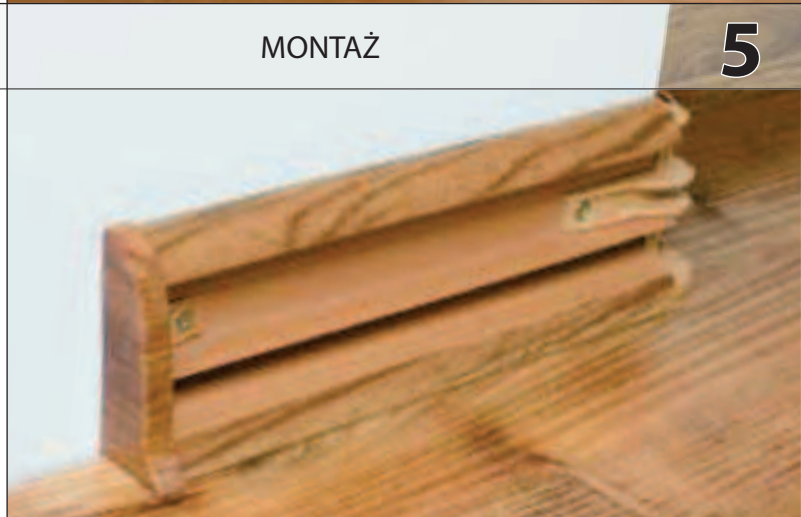

Монтаж

Montage

Installation

MONTAŻ

6

Kolejnym etapem jest montaż narożników zewnętrznych poprzez nasunięcie ich na element montażowy. Kończąc montaż zamykamy listwę na całej długości.

The next step is assembly of the external corners by overlapping them to the assembly element. Close the strip at the entire length to finish the assembling.



KSZTAŁTOWNIKI DLA MAJSTERKOWICZÓW



Kształtowniki dla majsterkowiczów to kolekcja aluminiowych elementów o zróżnicowanych kształtach i wymiarach, które mogą zostać wykorzystane w niezliczonych realizacjach. Ich użycie ogranicza wyłącznie pomysłowość użytkowników. Profile pozwalają na wykonanie wyposażenia pokoju według autorskiego projektu, zastosowanie we wnętrzach nieszablonowych rozwiązań architektonicznych czy renowację pamiątkowych mebli. Warto zauważyć, że wskazane realizacje mają wiele zalet: są wyjątkowe, funkcjonalne, niepowtarzalne, ale także niskobudżetowe.

Effector Easy Effect to klasyczne profile typu „zrób to sam”. Pozwalają realizować wiele nowoczesnych i efektownych pomysłów, niewielkim kosztem. Kształtowniki są wciąż uzupełniane o nowe elementy, zgodnie z oczekiwaniami odbiorców. Drugą część tej grupy asortymentowej stanowi komplet profili wykończeniowych do blatów kuchennych o uniwersalnych wymiarach.

DIY profiles is a collection of aluminium elements in different shapes and lengths that can be used in numerous projects. The only limit is users' imagination. Profiles enable you to create original room design, to use unique architectural solutions or to renovate old furniture. It is important to notice that such projects have numerous advantages: they are original, functional, unique, and low cost.

Effector Easy Effect are classic „DIY” profiles. They enable you to create numerous modern, attractive and low cost projects. The range of profiles is continuously expanded with new element according to the needs of users. The second part of this group are edging strips for kitchen countertops available in universal dimensions.

DIY PROFILES

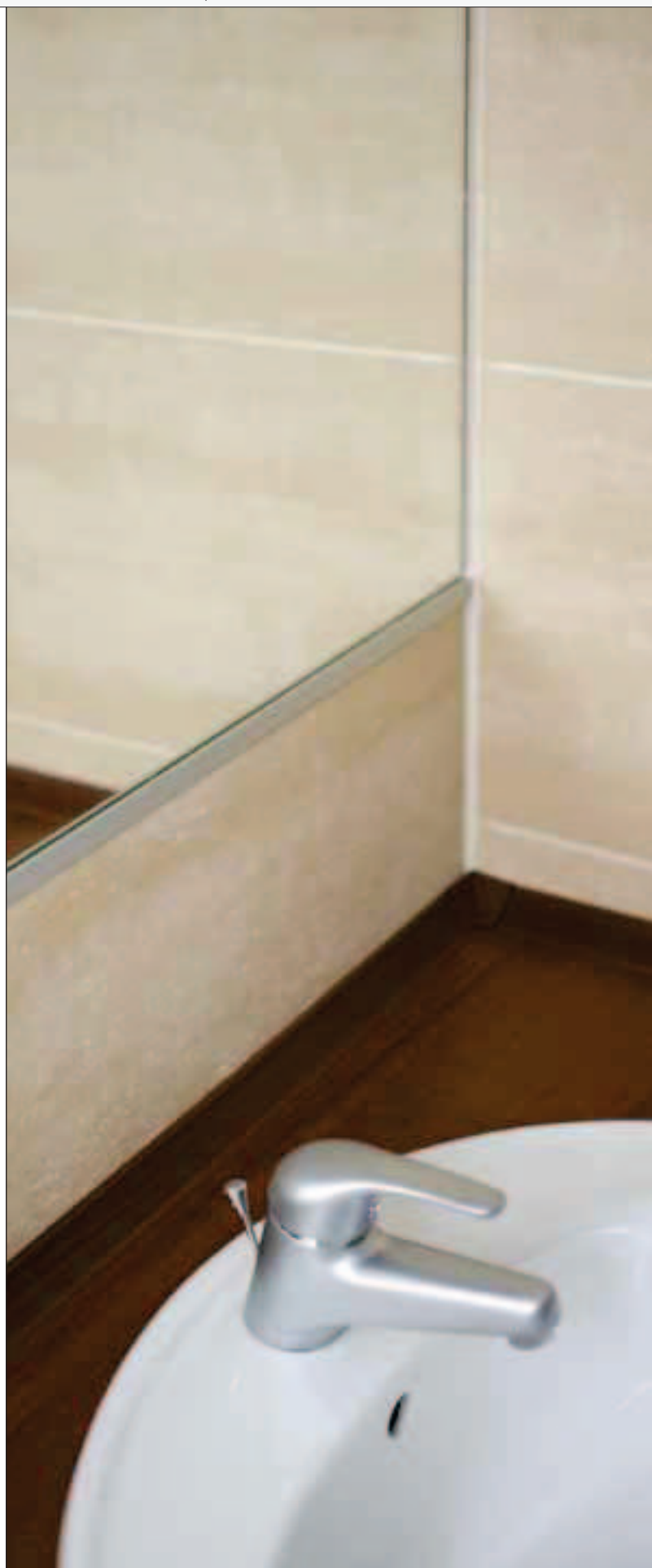

BASTLERPROFILE

ПРОФИЛИ ДЛЯ ОТДЕЛОЧНЫХ РАБОТ

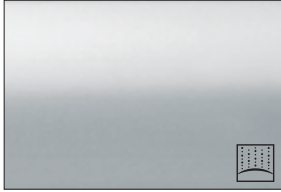

ALUMINIUM ANODOWANE

ANODISED ALUMINIUM | ALUMINIUM ELOXIERT | АНОДИРОВАННЫЙ АЛЮМИНИЙ

					
srebro - 01			zloto - 00		
silver	Silber	серебро	gold	Gold	золото

ALUMINIUM NATURALNE

NATURAL ALUMINIUM | NATUR ALUMINIUM | НАТУРАЛЬНЫЙ АЛЮМИНИЙ

		
naturalne - 90		
natural	Natur	натуральный

B00-B05

Płaskownik



Flat shape section

Flachleiste

Рейка плоская

	A	B
B00	15	3
B01	20	3
B02	25	2
B03	25	3
B04	40	3
B05	50	2

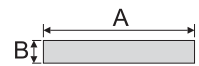

DłUGOŚĆ [m]
Length | Länge | Длина

1,0 | 2,0 | 3,0*

B10-B17

Kątownik równoramienny

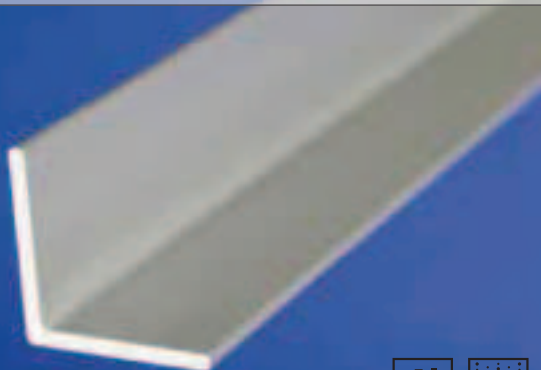

Equal-sided angle bar

Winkelprofil, gleichschenklig

Уголок
равносторонний

	A	B	C
B10	20	20	1
B11	25	25	2
B12	15	15	1,5
B13	12	12	2
B14	30	30	2
B15	35	35	3
B16	40	40	2
B17	50	50	3

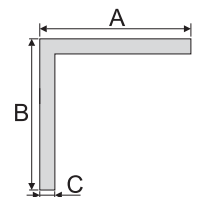

DłUGOŚĆ [m]
Length | Länge | Длина

1,0 | 2,0 | 3,0*

Уголок
разносторонний

Winkelprofil,
nicht gleichschenkl.

Non-equal sided angle bar

Катownik nierównoramienny **B20-B23**

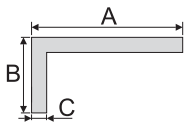

	A	B	C
B20	40	20	2
B21	30	20	2
B22	25	20	2
B23	20	10	2

DŁUGOŚĆ [m]
Length | Länge | Длина

1,0 | 2,0 | 3,0 *



Уголок с фаской

Winkelprofil, gefast

Chamfered angle bar

Катownik fazowany **B24-B25**

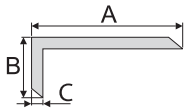

	A	B	C
B24	20	8	1,5
B25	14	10	1,5

DŁUGOŚĆ [m]
Length | Länge | Длина

1,0 | 2,0 | 3,0 *



рейка т-образная

T-Profil

T-bar

Teownik **B90**

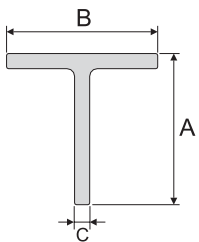

	A	B	C
B90	20	20	2

DŁUGOŚĆ [m]
Length | Länge | Длина

1,0 | 2,0 | 3,0 *



профиль
H-образный

H-Profil

H-bar

Haownik **B91**

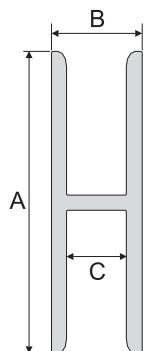

	A	B	C
B91	40	12	8

DŁUGOŚĆ [m]
Length | Länge | Длина

1,0 | 2,0 | 3,0 *



B82-B83

Naownik

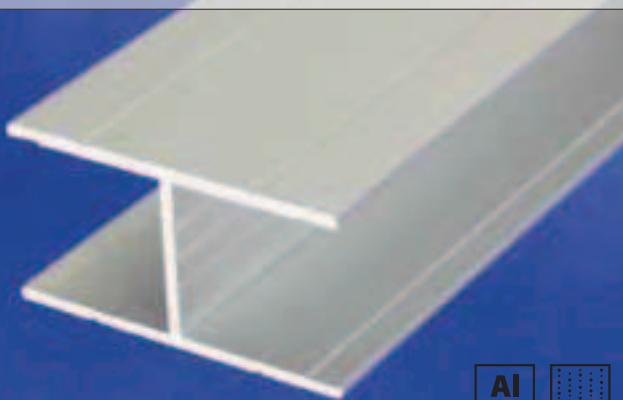

H-bar

H-Profil

Профиль "H"

	A	B	C
B82	27,6	40	25
B83	20,6	40	18

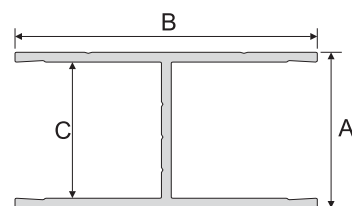

DŁUGOŚĆ [m]
 Length | Länge | Длина

1,0 | 2,0 | 3,0 *

B30

Ceownik



Channel bar

U-Profil

Швеллер

	A	B	C
B30	10	10	1,5

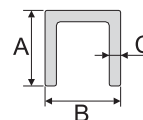

DŁUGOŚĆ [m]
 Length | Länge | Длина

1,0 | 2,0 | 3,0 *

B31

Ceownik nierównoramienny



Non-equal sided channel bar

U-Profil, nicht gleichschenklig

Швеллер разносторонний

	A	B	C
B31	19,3	18	14,3

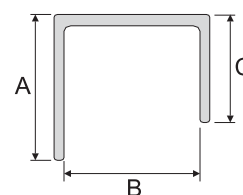

DŁUGOŚĆ [m]
 Length | Länge | Длина

1,0 | 2,0 | 3,0 *

B60-B63

Ceownik ryflowany



Ribbed channel bar

U-Profil, geriffelt

Швеллер рифленый

	A	B	C	D
B60	10	10,9	8,5	7,5
B61	10	12,9	10,5	9,5
B62	10	16,1	13,5	12,5
B63	21	21,1	18,5	17,5

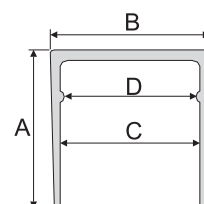

DŁUGOŚĆ [m]
 Length | Länge | Длина

1,0 | 2,0 | 3,0 *

Труба прямоугольная

Rohr, rechteckig

Rectangular tube

Rura prostokątna

B50-B52

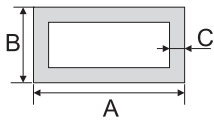

	A	B	C
B50	12	10	1
B51	15	10	1,2
B52	20	10	2

DŁUGOŚĆ [m]
Length | Länge | Длина

1,0 | 2,0 | 3,0 *



Труба квадратная

4kt Rohr

Square tube

Rura kwadratowa

B53-B56

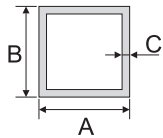

	A	B	C
B53	12	12	1
B54	15	15	1
B55	20	20	1
B56	25	25	1

DŁUGOŚĆ [m]
Length | Länge | Длина

1,0 | 2,0 | 3,0 *

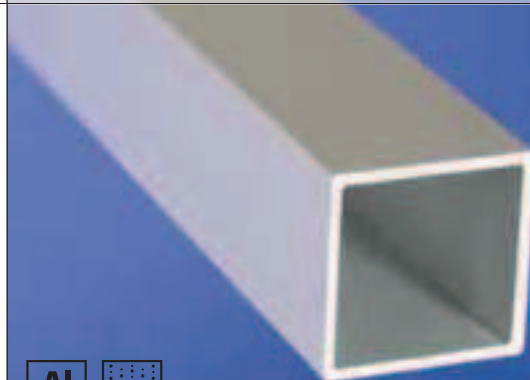

квадратный прут

Der quadratische Stab

Square bar

Pręt kwadratowy

B57-B58

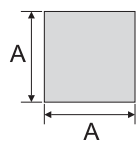

	A
B57	10
B58	15

DŁUGOŚĆ [m]
Length | Länge | Длина

1,0 | 2,0 | 3,0 *

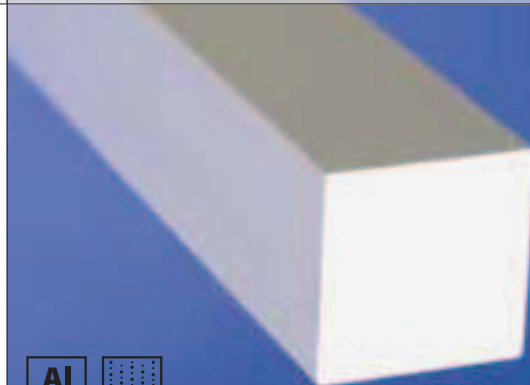

Швеллер

U-Profil

Channel bar

Ceownik

B80-B81

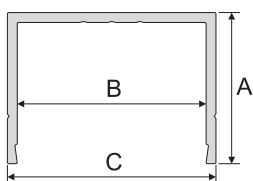

	A	B	C
B80	20	25	27,6
B81	20	18	20,6

DŁUGOŚĆ [m]
Length | Länge | Длина

1,0 | 2,0 | 3,0 *



B32-B36

Pręt okrągły



Round bar

Der runde Stab

круглый прут

	A
B32	5
B33	8
B34	10
B35	12
B36	15

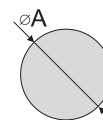

DŁUGOŚĆ [m] | 1,0 | 2,0 | 3,0 *
Length | Länge | Длина

B40-B45

Rura



Tube

Rundrohr

Труба

	A	B
B40	5	1
B41	8	1
B42	10	1
B43	12	1
B44	15	1
B45	20	1

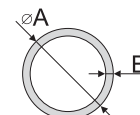

DŁUGOŚĆ [m] | 1,0 | 2,0 | 3,0 *
Length | Länge | Длина

ALUMINIUM ANODOWANE

ANODISED ALUMINIUM | ALUMINIUM ELOXIERT | АНОДИРОВАННЫЙ АЛЮМИНИЙ



złoto - 00

gold | Gold | золото

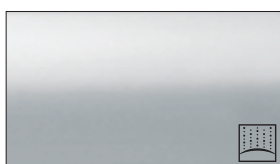

srebro - 01

silver | Silber | серебро



szampan - 02

champagne | Champagne | шампанское



brąz - 03

bronze | Braun | коричневый

ALUMINIUM LAKIEROWANE

LACQUERED ALUMINIUM | LACKIERTES ALUMINIUM | ЛАКИРОВАННЫЙ АЛЮМИНИЙ



biały - 007

white | Weiß | белый



niebieski - 085

blue | Blau | голубой



ciemna zieleń - 086

dark green | Dunkelgrün | темно-зеленый



ciemny czerwony - 088

dark red | Dunkelrot | темно-красный



beż - 081

beige | Beige | бежевый



bukowy - 080

beech | Buchenholz | буковый



brąz - 082

brown | Braun | коричневый



ciemny brąz - 083

dark brown | Dunkelbraun | темно-коричневый

профиль окантовочный правый | Abschlussleiste, rechts | Right ending profile

Profil zakończeniowy prawy **K01**

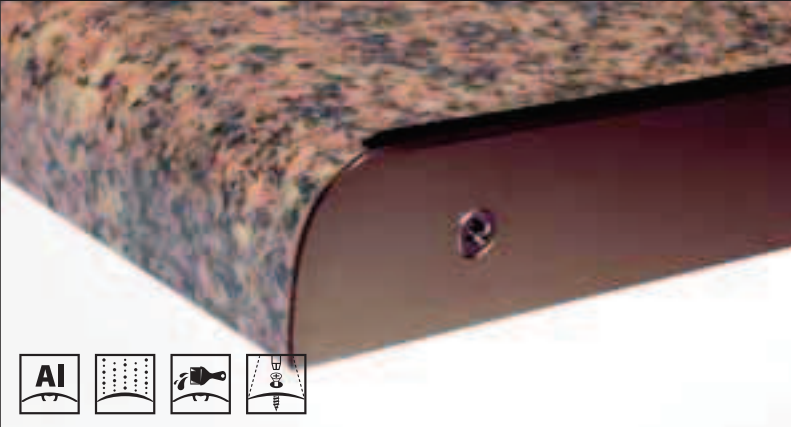
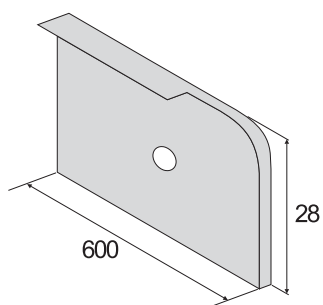

профиль окантовочный левый | Abschlussleiste, links | Left ending profile

Profil zakończeniowy lewy **K02**

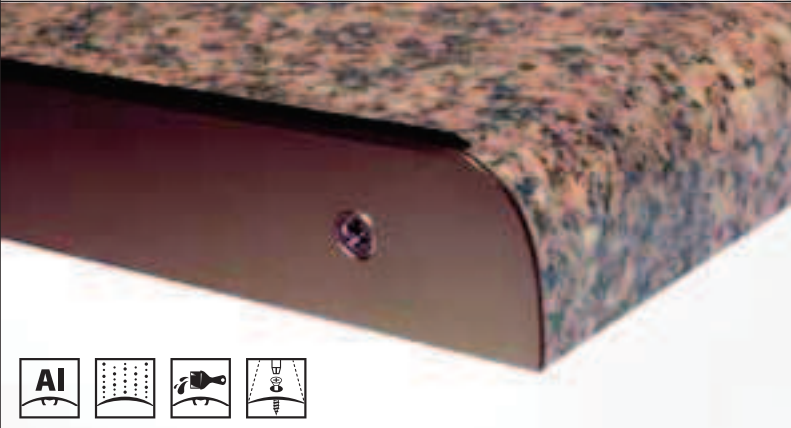
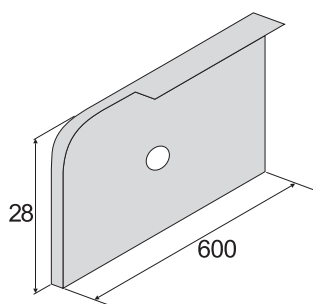

Профиль соединительный гнутый | Verbindungsleiste, elastisch | Bowled joining profile

Profil łączeniowy gięty **K03**

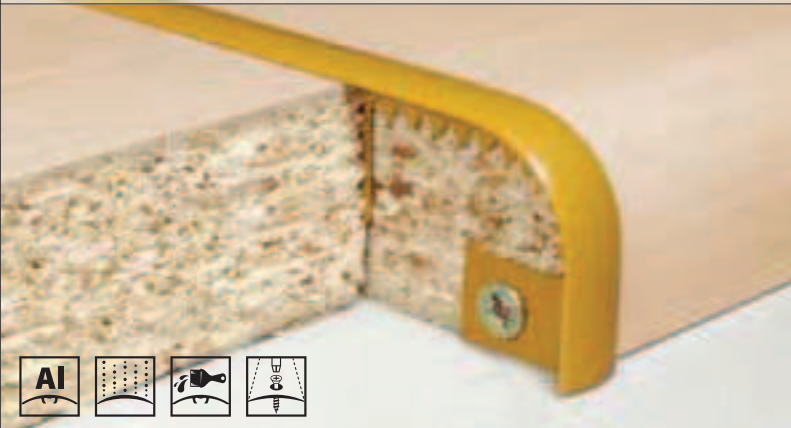
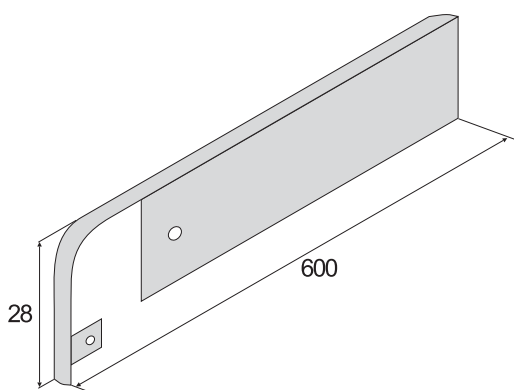

Профиль соединительный | Verbindungsleiste | Joining profile

Profil łączeniowy **K04**

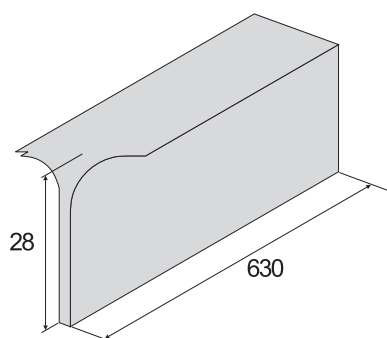

PROFILE BUDOWLANE PVC



Remont oraz wykończenie wnętrz to zadania, które realizujemy, uwzględniając wszystkie swoje potrzeby, ale jednocześnie sprawnie i szybko. Dlatego niejednokrotnie, już na etapie podejmowania prac, decydujemy o wykorzystaniu systemu suchej zabudowy, zamiast ciężkich materiałów budowlanych. W tej technologii można tworzyć nie tylko lekkie ściany działowe, ale również sufity podwieszane, a także suche tynki, umożliwiające szybkie powstawanie ścian o idealnie prostych kątach.

Effector Fantazja Effect to szeroki asortyment listew i profili budowlanych, produkowanych ze spienionego PVC. Wachlarz użytecznych kształtów oraz paleta atrakcyjnych kolorów, ułatwiają wykonanie najwymyślniejszych, fantazyjnych aranżacji z systemów suchej zabudowy, to jest ścian, sufitów podwieszanych, elementów zabudowy poddaszy. Inne, równie ważne zadanie spoczywające na tych elementach, to maskowanie ewentualnych nierówności pomiędzy materiałami, służącymi do wykończenia wnętrz.

Repairs and interior design must be done quickly, easily and including all our needs. This is the reason why sometimes we make a decision to use drywall systems instead of heavy construction materials. In this technology we can build light partition walls, suspended ceiling, and drywalls that enable us to build walls with perfectly straight angles.

Effector Fantazja Effect is a wide variety of strips and construction profiles made of foamed PVC. The range of useful shapes and variety of attractive colours facilitate making original and unexpected drywall designs such as walls, suspended ceilings, attic construction elements. The other, very important task performed by these elements is covering possible uneven joints between material used for interior finish.

PVC DIY PROFILES

DIE KUNSTOFFBAUPROFILLE

СТРОЙПРОФИЛИ ПВХ

BEZPIECZEŃSTWO



SAFETY

TRWAŁOŚĆ



DURABILITY

ELEGANCJA



ELEGANCE

BOGATA GAMA KOLORYSTYCZNA



COLORFUL

NOWOCZESNY DESIGN



MODERN DESIGN

PRODUKT POLSKI



POLISH PRODUCT

WYJĄTKOWA ELASTYCZNOŚĆ



UNIQUE ELASTIC

EKSPRESOWY MONTAŻ



QUICK MOUNT

ODPORNOŚĆ NA ZARYSOWANIA



SCRATCH RESISTANT

PRZYJAZNE ŚRODOWISKU



ECO-FRIENDLY

BEZ ZAWARTOŚCI OŁOWIU











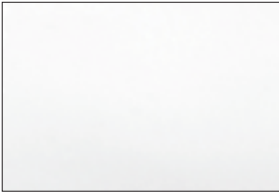

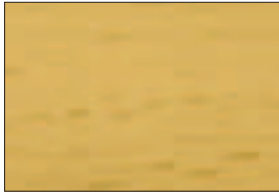

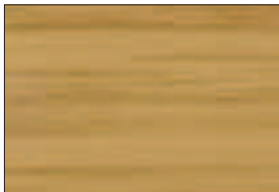
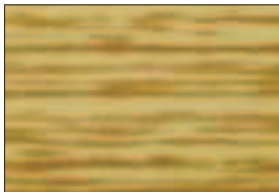

LEAD FREE

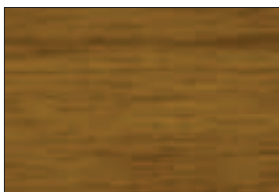

PROFILE BUDOWLANE PVC

PVC DIY PROFILES | DIE KUNSTSTOFFBAUPROFILE | СТРОЙПРОФИЛИ ПВХ

				
biały - 8000	buk jasny - 2800	buk - 0800	sosna - 3000	buk różowy - 0801
white Weiss белый	light beech Buche hell светлый бук	beech Buche бук	pine Kiefer сосна	pink beech Buche Rosa розовый бук
				
olcha - 2300	dąb jasny - 2900	dąb ciemny - 0901	dąb rustykalny - 0902	mahoń - 0240
alder Erle ольха	light oak Eiche hell светлый дуб	dark oak Eiche dunkel темный дуб	rustic oak Eiche Rustical дуб rustykalny	mahogany Mahagoni красное дерево
				
wiśnia - 0220	orzech - 0270	orzech grecki - 0271	orzech czerwony - 0272	wenge Kongo - 4201
cherry Kirsch-baum вишня	nut Nuss орех	greek walnut Nuss Griechisch греческий орех	red walnut Nuss Rot красный орех	Congo wenge Wenge Kongo венге Конго
				
dąb arctic - 20904				
arctic oak Eiche Arctic дуб арктиц				

F01-F04

Listwa budowlana



PVC

building profile

Bauleiste

стройпрофиль

KOLOR | wszystkie kolory | all colours | alle Farben | все цвета
Colour | Farbe | Цвет

	B	H
F01	40	6
F02	50	7
F03	60	8
F04	70	9

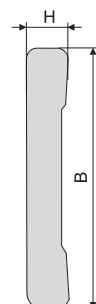

DŁUGOŚĆ [m]
Length | Länge | Длина

2,2

маскирующий
профиль

Maskierleiste

masking profile

Listwa maskująca

F05-F06

KOLOR | wszystkie kolory | all colours | alle Farben | все цвета
Colour | Farbe | Цвет

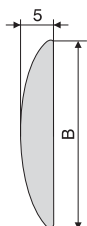

	B
F05	30
F06	19

DŁUGOŚĆ [m] | Length | Länge | Длина | 2,7

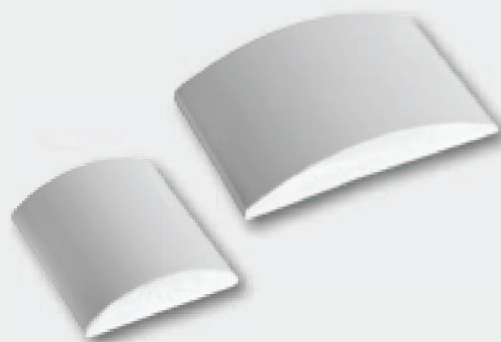

PVC

четверть круга

Viertelstab

quadrant moulding

Ćwierćwałek „13 x 8”

F07

KOLOR | wszystkie kolory | all colours | alle Farben | все цвета
Colour | Farbe | Цвет

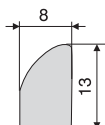

DŁUGOŚĆ [m] | Length | Länge | Длина | 2,7



PVC

четверть круга

Viertelstab

quadrant moulding

Ćwierćwałek „10”; „14”

F08-F09

KOLOR | wszystkie kolory | all colours | alle Farben | все цвета
Colour | Farbe | Цвет

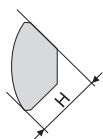

	H
F08	10
F09	14

DŁUGOŚĆ [m] | Length | Länge | Длина | 2,7



PVC

стройугол

Eckleiste

corner profile

Narożnik budowlany „20”; „30”

F10-F11

KOLOR | wszystkie kolory | all colours | alle Farben | все цвета
Colour | Farbe | Цвет

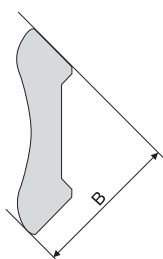

	B
F10	20
F11	30

DŁUGOŚĆ [m] | Length | Länge | Длина | 2,7



PVC

F12-F13

Profil T „16/8”; „26/12”



PVC

T-bar

T Profil

профиль Т-образный

KOLOR | wszystkie kolory | all colours | alle Farben | все цвета
Colour | Farbe | Цвет

	H	B
F12	16	8
F13	26	12

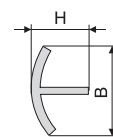

DŁUGOŚĆ [m] | Length | Länge | Длина | 2,7

F17

Profil do suchego tynku prosty



PVC

profile for plaster board straight

Trockenbauprofil gerade

простой профиль к сухой штукатурке

KOLOR | biały | white | Weiss | белый
Colour | Farbe | Цвет

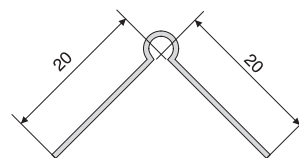

DŁUGOŚĆ [m] | Length | Länge | Длина | 2,5

F18

Profil do suchego tynku łukowy



PVC

profile for plaster board curved

Trockenbauprofil gebogen

дугобразный профиль к сухой штукатурке

KOLOR | biały | white | Weiss | белый
Colour | Farbe | Цвет

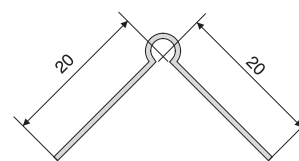

DŁUGOŚĆ [m] | Length | Länge | Длина | 2,5

F23

Narożnik uniwersalny

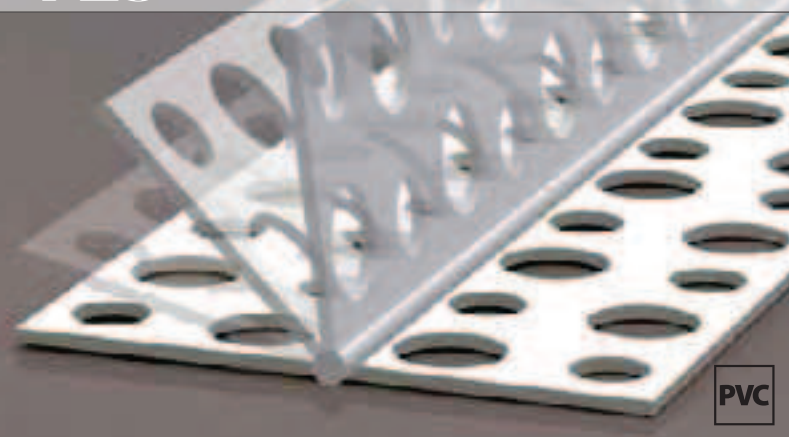

PVC

Multipurpose corner

Allzweckecke

Уголок универсальный

KOLOR | biały | white | Weiss | белый
Colour | Farbe | Цвет

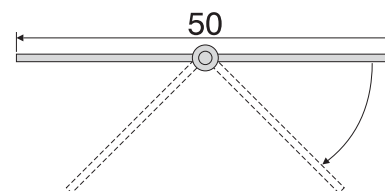

DŁUGOŚĆ [m] | Length | Länge | Длина | 2,5 | 3,0

уголок настенный

Wandwinkelprofil

wall corner

Narożnik ścienny

F24

KOLOR
Colour | Farbe | Цвет

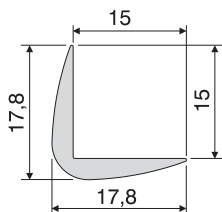

DŁUGOŚĆ [m]
Length | Länge | Длина

2,7

PVC

DODAKTOWE KOLORY KĄTOWNIKÓW F14-F21

ADDITIONAL COLOURS FOR F14-F21 PROFILES | ZUSÄTZLICHE FARBEN DES WINKELPROFILS F14-F21 | ДОПОЛНИТЕЛЬНЫЕ ЦВЕТА УГОЛКОВ F14-F21

kość słoniowa - 9011	jasny beż - 8701	karmel - 9012	kawowy - 9015	brązowy - 8600	jasny szary - 8901
ivory Efenbein слоновая кость	light beige Beige hell светло-бежевый	caramel Karamell карамель	coffee Мокса кофейный	brown Braun коричневый	light grey Hell Grau светло-серый
seledyn - 9016	czarny - 8800	zielony - 9017	kanarek - 9018	ceglany - 9019	
willow-green Meergrün салатный	black Schwarz черный	green Grün зеленый	canary yellow Kanariengelb светло-желтый	brick-red Ziegelstein кирпичный	

Kątownik

угольник

L Profil

angle bar

F14 F15 F16 F19
F20 F21 F22*

KOLOR
Colour | Farbe | Цвет

F14-F16	wszystkie kolory	all colours	alle Farben	все цвета
F19-F21	dodatkowe kolory	Additional colours	Zusätzliche Farben	Дополнительные цвета
F22*	wszystkie kolory	all colours	alle Farben	все цвета

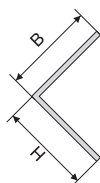

	B	H
F14	15	15
F15	20	20
F16	25	25
F19	10	10
F20	20	10
F21	30	30
F22	40	40

DŁUGOŚĆ [m]
Length | Länge | Длина

2,75

PVC

LISTWY WYKOŃCZENIOWE PVC



Trudno wyobrazić sobie pomieszczenie, zupełnie pozbawione listew wykończeniowych. To one stanowią estetyczne połączenie różnych materiałów podłogowych, jeśli trzeba zakańczają podłogę czy schody, lub zabezpieczają powierzchnię, jednocześnie wyrównując różnicę poziomów pomiędzy poszczególnymi elementami podłóg.

Kolekcja listew **Eco** wykonana jest z najwyższej jakości materiału PVC, który następnie został okleinowany drewnopodobną folią, o dużej odporności na ścieralność. Listwy z PVC stanowią interesującą alternatywę - również ze względów ekonomicznych - dla profili aluminiowych.

It is hard to imagine interior without any finishing strips. They are elegant and attractive joints of various flooring materials. Finishing strips can be also used to finish the floor, stairs or to protect the surface concurrently compensating for differences in flooring levels.

Strip collection **Eco** is made of top quality PVC which is covered with wooden-like film which is highly resistant to abrasion. PVC strips are an interesting alternative – also for economic reasons – to aluminium profiles.

PVC FINISHING PROFILES

KUNSTOFFABSCHLUSSPROFILE

ЛАМИНИРОВАННЫЕ
ПРОФИЛИ ПВХ



PVC OKLEINOWANE

VENEERED PVC | PVC - FURNIERLEISTEN | ЛАМИНИРОВАННЫЙ ПВХ

buk - 08	buk jasny - 28	buk czerwony - 38	dąb - 09	dąb jasny - 29										
beech	Buche	бук	light beech	Buche hell	светлый бук	copper beech	Blutbuche	красный бук	oak	Eiche	дуб	light oak	Eiche hell	светлый дуб
dąb złocisty - 0909	wiśnia - 22	wiśnia jasna - 2201	kasztan - 31	kasztan japoński - 3101										
golden oak	Eiche Gold	дуб золотистый	cherry	Kirschbaum	вишня	bright cherry-tree	Kirschbaum hell	вишня светлая	chestnut	Kastanie	каштан	Japanese chestnut	Japanische Kastanie	каштан японский
sosna - 30	sosna biała - 35	klon - 25	olcha - 23	hikora - 32										
pine	Kiefer	сосна	white pine	Kiefer Weiss	белая сосна	maple	Ahorn	клен	alder	Erl	ольха	hickory	Hikorybaum	хикора
wiąz - 34	mahoń - 24	mahoń Togo - 2402	afrezja - 33	orzech Chile - 2701										
elm	Ulme	вяз	mahogany	Mahagoni	красное дерево	Togo mahogany	Mahagoni Togo	красное дерево Того	afrezy	Afrezy	афрезия	Chile nut	Nussbaum Chile	орех Чили
teak indyjski - 4500	heban afrykański - 4501	wenge Kongo - 4201	dąb bielony - 20901	dąb Mocca - 20902										
Indian teak	Indischer Teak	тик Индийский	African ebony	Afrikanischer Heban	черное фриканское Дерево	Congo wenge	Wenge Kongo	венге Конго	white oak	Eiche gebleicht	беленный дуб	Mocca oak	Eiche Mocca	дуб Моща



dąb antyczny - 20903

antique oak	Eiche antik	дуб античный
-------------	-------------	--------------



dąb arctic - 20904

arctic oak	Eiche Arctic	дуб арктиц
------------	--------------	------------



dąb bursztynowy - 20905

Amber oak	Eiche Bernstein	янтарный дуб
-----------	-----------------	--------------



dąb koniakowy - 20906

Cognac oak	Eiche Cognac	коняковский дуб
------------	--------------	-----------------



dąb piaskowy - 20907

Sandy oak	Eiche Sand	песочный дуб
-----------	------------	--------------



dąb piwny - 20908

Bery oak	Eiche Hellbraun	пивной дуб
----------	-----------------	------------



dąb zamkowy - 20910

Castle oak	Schloss Eiche	замочный дуб
------------	---------------	--------------



merbau - 20944

merbau	Merbau	мербау
--------	--------	--------

Уголок самоклеющийся

Winkelprofil SELBSTKLEBEND

Angle bar SELF-ADHESIVE

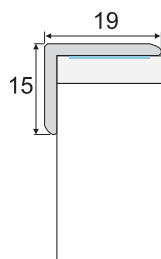

DŁUGOŚĆ [m] | 1,0 | 2,0
 Length | Länge | Длина

Kątownik SAMOPRZYLEPNY

E30



Уголок самоклеющийся

Winkelprofil SELBSTKLEBEND

Angle bar SELF-ADHESIVE

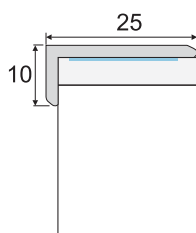





DŁUGOŚĆ [m] | 1,0 | 2,0
 Length | Länge | Длина

Kątownik SAMOPRZYLEPNY

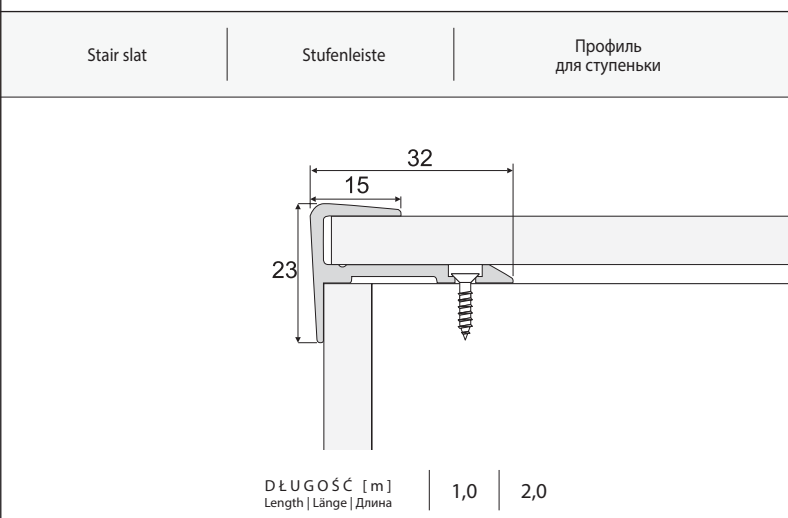
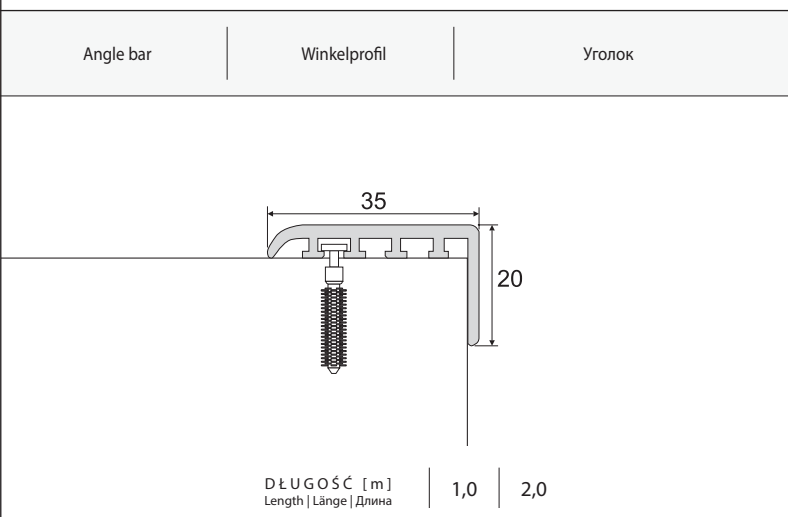
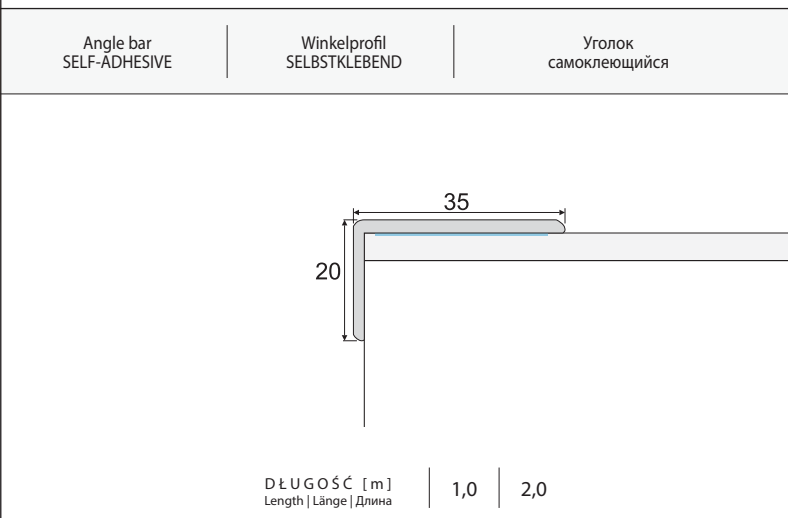
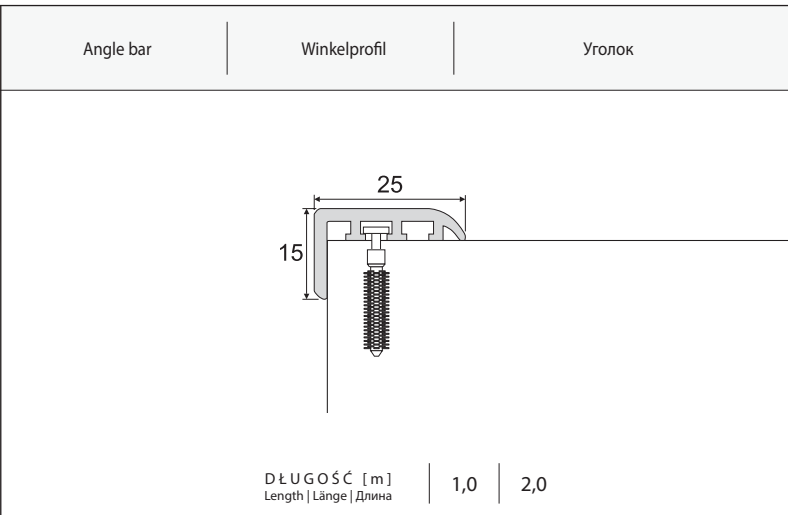
E31

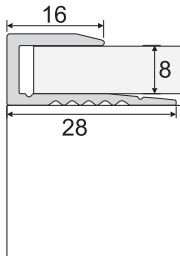

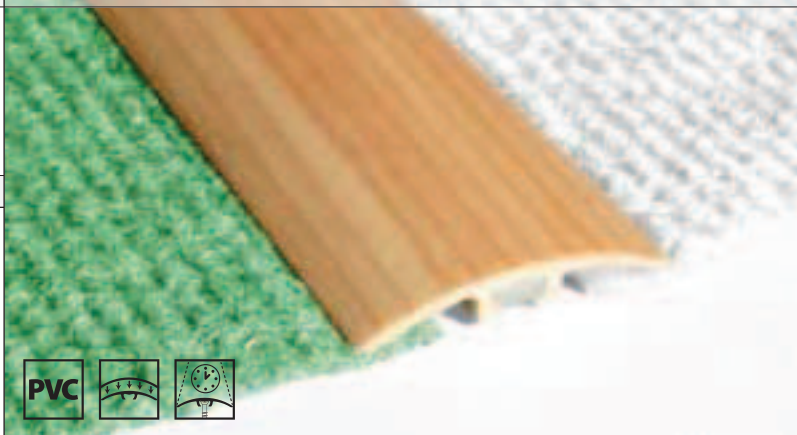

<p>Профиль окантовочный</p>	<p>Abschlussleiste</p>	<p>Edging strip</p>	<p>Listwa zakończeniowa E63</p>
 <p>DŁUGOŚĆ [m] Length Länge Длина</p> <p>1,0 2,0</p>			 <p>PVC </p>
<p>Профиль быстрого монтажа самоклеющийся</p>	<p>Leiste, easy fix SELBSTKLEBEND</p>	<p>Quick-mounted bar SELF-ADHESIVE</p>	<p>Listwa szybkiego montażu z klejem E64</p>
 <p>DŁUGOŚĆ [m] Length Länge Длина</p> <p>1,0 2,0</p>			 <p>PVC </p>
<p>Профиль быстрого монтажа самоклеющийся</p>	<p>Leiste, easy fix SELBSTKLEBEND</p>	<p>Quick-mounted bar SELF-ADHESIVE</p>	<p>Listwa szybkiego montażu z klejem E66</p>
 <p>DŁUGOŚĆ [m] Length Länge Длина</p> <p>1,0 2,0</p>			 <p>PVC </p>
<p>Профиль быстрого монтажа</p>	<p>Leiste, easy fix</p>	<p>Quick-mounted bar</p>	<p>Listwa szybkiego montażu E68</p>
 <p>DŁUGOŚĆ [m] Length Länge Длина</p> <p>1,0 2,0</p>			 <p>PVC </p>

LISTWY DO GLAZURY I TERAKOTY PVC



Effector Rainbow Effect to szeroki wachlarz profili wykończeniowych, używanych zwłaszcza w łazienkach i pokojach kąpielowych. Stanowią element dekoracyjny, który jednocześnie doskonale uszczelnia zakończenia płytek ceramicznych oraz zabezpiecza ich brzegi przed uszkodzeniem. Łączą również wewnętrzne i zewnętrzne naroża płytek oraz maskują ewentualne nierówności podłoża.

Imponująca oferta kolorystyczna listew do glazury i terakoty z PVC, zawiera blisko 100 kolorów (jednolitych oraz tzw. marmurkowych), a tym samym odpowiada na zróżnicowane potrzeby inwestorów.

Do szerokiej propozycji profili należy także nowość: samoprzylepny profil uniwersalny w kolorze białym, który zapewnia doskonałą izolację połączeń pomiędzy urządzeniami sanitarnymi, a ścianą lub glazurą.

Effector Rainbow Effect is a wide range of finishing profiles used especially in bathrooms. They are decorative elements that also seal edgings of ceramic tiles and protect them against damage. They are also used to join inside and outside tile angles and cover uneven floorings.

An impressive colour range of PVC tile and terracotta strips includes nearly 100 colours (uniform and so-called marbled). Thanks to this variety the collection can meet various requirements of investors.

Wide variety of profiles includes also a new product: adhesive universal profile in white colour, which ensures perfect insulation of joints between sanitary equipment and wall or tiles.

PVC STRIPS FOR GLAZE
 AND TERAKOTA TILES

FLIESENKUNSTOFFPROFILE

ПРОФИЛИ ДЛЯ КАФЕЛЯ ПВХ















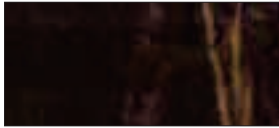





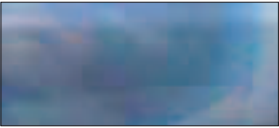
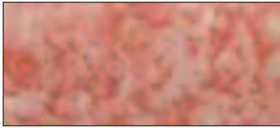
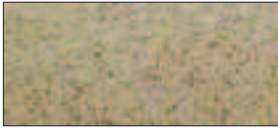

KOLORY JEDNOLITE

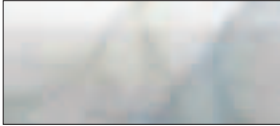
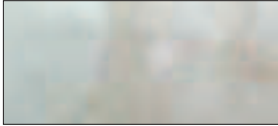
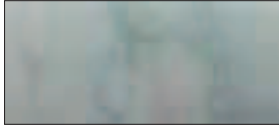
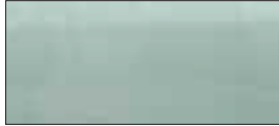
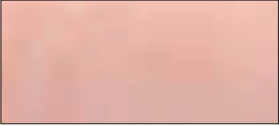
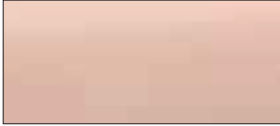
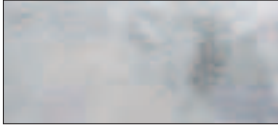
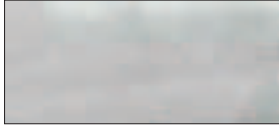
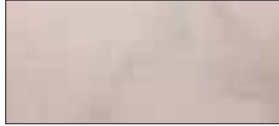
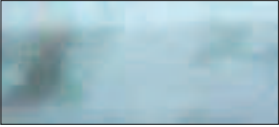
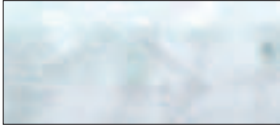
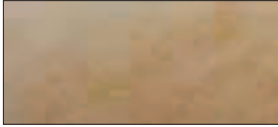
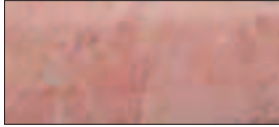
PLAIN COLOURS | STANDARD FARBEN | ЦВЕТ

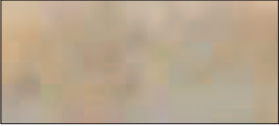
biały-8000 white Weiss белый	kość słoniowa-9011 ivory Elfenbein слоновая кость	beżowy jasny-8701 light beige Beige hell светлый беж	beżowy-8700 beige Beige беж	karmel-9012 caramel Karamell карамель
brązowy-8600 brown Braun коричневый	brązowy ciemny-9020 dark brown Dunkel Braun темно-коричневый	czarny-8800 black Schwarz черный	różowy-9021 pink Rosa розовый	różowy jasny-9013 light pink Rosa hell светло-розовый
szary jasny-8901 light grey Hell Grau светло-серый	szary-9022 grey Grau серый	szary ciemny-9023 Dark grey Dunkel Grau темно-серый	srebrny mat-9024 matt silver Silber Matt серебряный матовый	seledyn jasny-9014 light willow-green Blaugrün светлый салатный
seledyn-9016 willow-green Meergrün салатный	zielony jasny-9025 light green Hell Grün светло-зеленый	zielony-9017 green Grün зеленый	 błękit-9026 azure Azur бледно-голубой	niebieski jasny-9027 light blue Hell Blau голубой
niebieski-9028 blue Blau темно-голубой	granatowy-9029 dark blue Dunkelblau синий	żółty-9030 yellow Gelb желтый	czzerwony-9031 red Rot красный	groszek-9032 green pea Erbse гороховый
burgund-9033 burgundy Burgund бордо	 błękit pastelowy-9034 pastel azure Azur Pastel голубая пастель	fiolet-9035 violet Violett фиолетовый	kanarek-9018 canary yellow Kanariengelb светло-желтый	cegła-9019 brick-red Ziegelstein кирпичный
kawowy-9015 coffee Мосса кофейный	mięta-9036 mint Mint мята	kremowy-9000 creamy Cremefarbig кремовый	miedziany-9062 copper Messing медный	

KOLORY MARMURKOWE

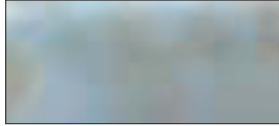
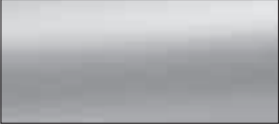
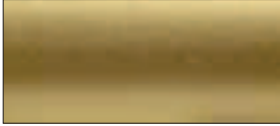
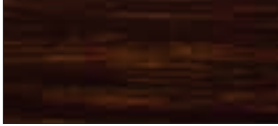
MARBLED COLOURS | MARMOR FARBEN | МРАМОР

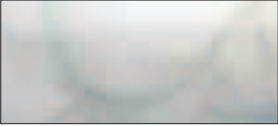
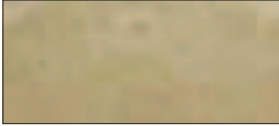
				
biały marm.-8001 white marbled Weiss Marmor белый	beżowy marm.-9001 beige marbled Beige Marmor беж	szary marm.-9037 grey Marmor Grau серый	czekoladowy marm.-9038 chocolate Schoko шоколадный	czarny granit-9039 black granite Granit Schwarz черный гранит
				
czerwony marm.-9002 red marbled Rot Marmor красный	zielony marm.-9003 green marbled Grün Marmor зеленый	granatowy marm.-9040 dark blue Dunkelblau синий	złoty-0000 gold Gold золото	srebrny połysk-0001 silver gloss Silber Glanz серебро блеск
				
niebieski marm.-9041 blue Blau Marmor голубой	różowy marm.-9042 pink Rosa Marmor розовый	piaskowy beż-9004 sand-beige Sand Beige песочно-бежевый	ceglany-9005 brick-red Ziegelstein кирпичный	alabastrowy-9006 alabaster Alabaster алебастровый
				
żółty marm.-9043 yellow Gelb Marmor желтый	lazurowy marm.-9044 azure Lazur лазурь	cappuccino-9007 cappuccino Cappuccino капучино	turkusowy-9045 turquoise Türkis морская волна	seledynowy-9046 willow-green Blaugrün салатный
				
róż jasny marm.-9047 light pink Rosa Hell Marmor светло-розовый	różowy pastel-9048 pastel pink Rosa Marmor розовая пастель	perłowy-9049 pearl Perle перламутр	seledyn aksamitny-9050 downy willow-green Blaugrün светло-салатный	magnolia-9008 magnolia Magnolia магнолия
				
 błękitny marm.-9051 azure Hellblau Marmor светло-голубой	szara perła-9052 grey pearl Perle Grau серый перламутр	jasny beż-9009 light beige Beige hell светлый беж	róż indyjski-9053 Indian pink Rosa India индийская роза	piasek pustyni-9054 desert sand Sahara песок пустыни
				
mozaika żółta-9055 yellow mosaic Gelb Mosaik желтая мозаика	granit-9056 granite Granit гранит	kalcyt-9057 calcite Calcite кальцит	zielen pastelowa-9058 pastel green Grün Pastell зелень пастель	mozaika błękitna-9059 blue mosaic Hellblau Mosaik голубая мозаика
				
srebro-9060 silver Silber серебро	złoto mat-9061 gold mat Gold Matt золото матовое	wenge-4200 wenge Wenge венге	dąb-0900 oak Eiche дуб	olcha-2300 alder Erle ольха
				
lazurowy-9063 azure Lasur лазурь	sahara-9010 sahara Sahara сахара			

P53

Listwa krawędziowa

Edge strip

Randleiste

Профиль угловой



PVC

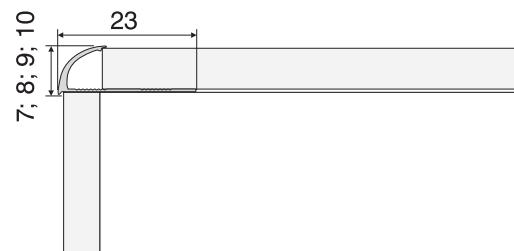

DŁUGOŚĆ [m] | 2,5
Length | Länge | Длина

P96

Listwa wewnętrzna

Inner strip

Innenleiste

внутренний



PVC

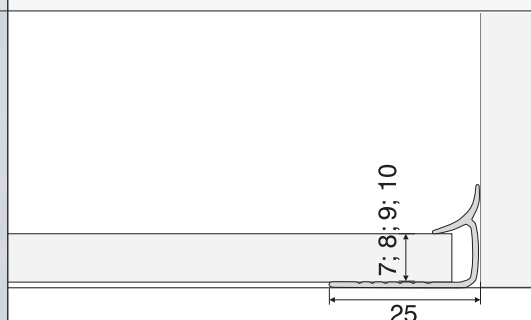

DŁUGOŚĆ [m] | 2,5
Length | Länge | Длина

P56

Profil wannowy samoprzylepny z akcesoriami

bath strip self-adhesive with accessories

Das Profil zur Badenwanne mit Zubehören selbstklebend

ванный профиль самоклеющийся с аксессуарами

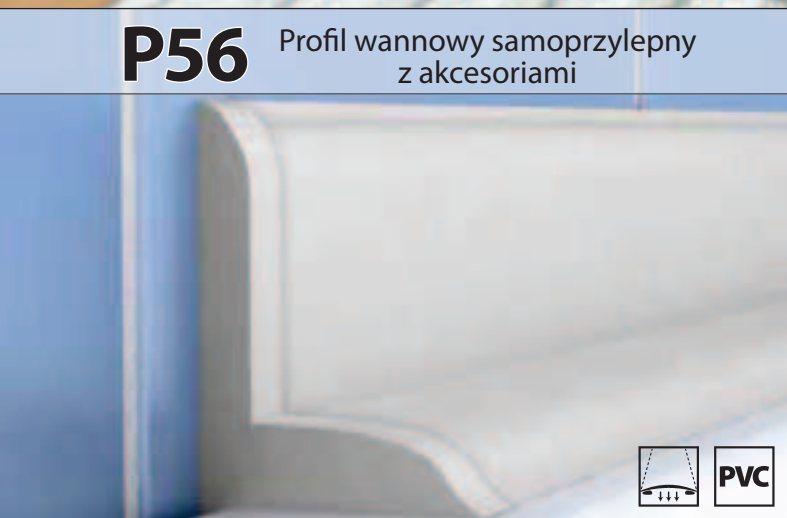

PVC

KOLOR | biały | white | Weiß | белый
Colour | Farbe | Цвет

Aksesoria: 2 x Narożnik wewnętrzny, zakończenie prawe i lewe
Accessories: 2 x internal corner profile, right and left ending profile
Zubehör: 2 x Innenecke, 2 x Endstuecke
Аксессуары: 2 x внутренний уголок, оканчание правое или левое



DŁUGOŚĆ [m] | 1,83
Length | Länge | Длина

P58-P59

Profil wannowy elastyczny samoprzylepny

bath profile under tiles

Das Profil zur Badenwanne elastisch, selbstklebend

эластический ванный профиль самоклеющийся



PVC

KOLOR | biały | white | Weiß | белый
Colour | Farbe | Цвет

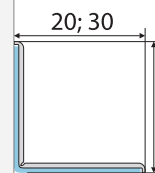

P58 - 40 mm (20x20 mm)
P59 - 60 mm (30x30 mm)

DŁUGOŚĆ [m] | 3,4
Length | Länge | Длина

Рейка твердо-мягкая
 выравнивающая ПВХ

Dehnungsprofil,
 hart – weich PVC

Hard-soft dilatation
 strip PVC

Listwa twardo-mięka
 dylatacyjna PVC

P90-P92

KOLOR
 Colour | Farbe | Цвет

biały - 80
 szary - 89
 brąz - 86
 czarny - 88

white
 grey
 brown
 black

Weiß
 Grau
 Braun
 Schwarz

белый
 серый
 коричневый
 черный

	A	B	C
P90	8	8	21
P91	10	8	21
P92	12,5	8	21

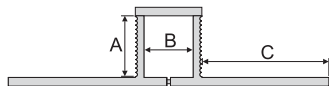

DŁUGOŚĆ [m]
 Length | Länge | Длина

1,0 | 2,0 | 3,0

PVC



EKSPozyTORY

STANDS | DISPLAYS | ОТОБРАЖАЕТ

EFFECT 40 TRIO

EFFECT 60 TRIO

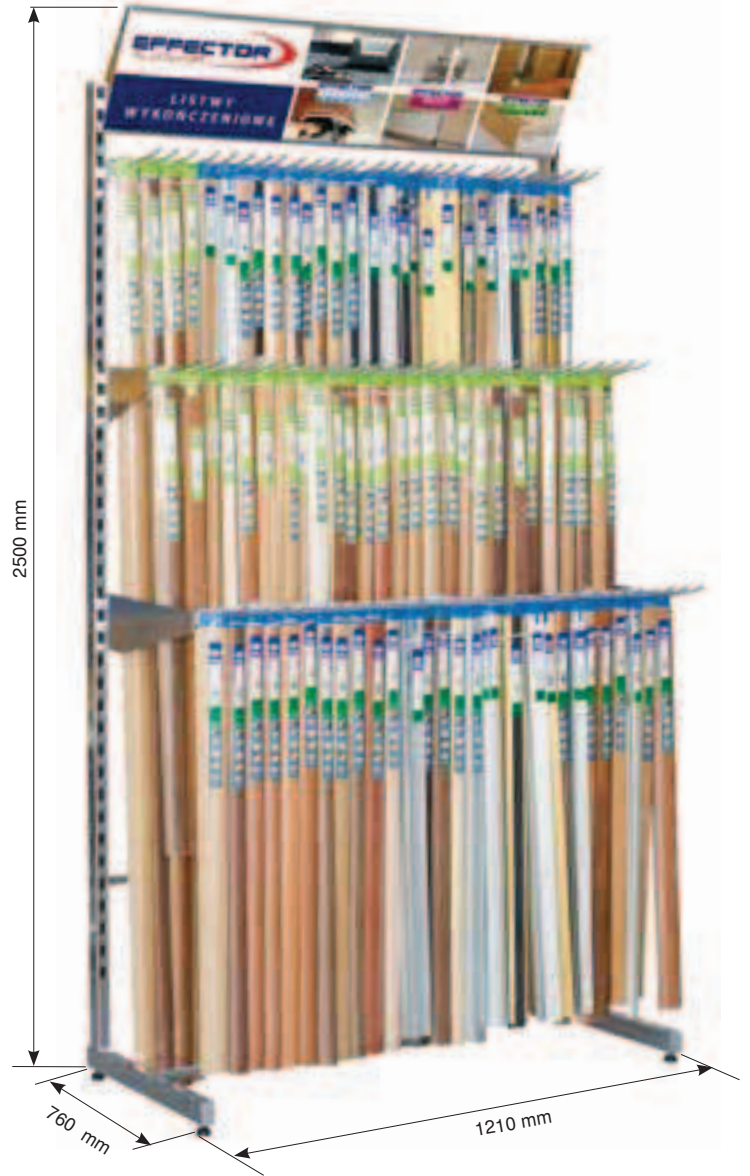

EKSPozyTORY

STANDS | DISPLAYS | ОТОБРАЖАЕТ

EFFECT 40

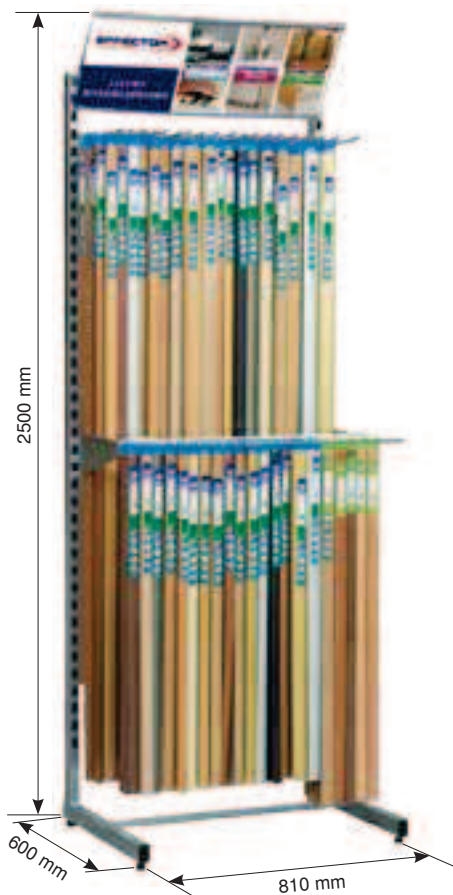

EFFECT 60

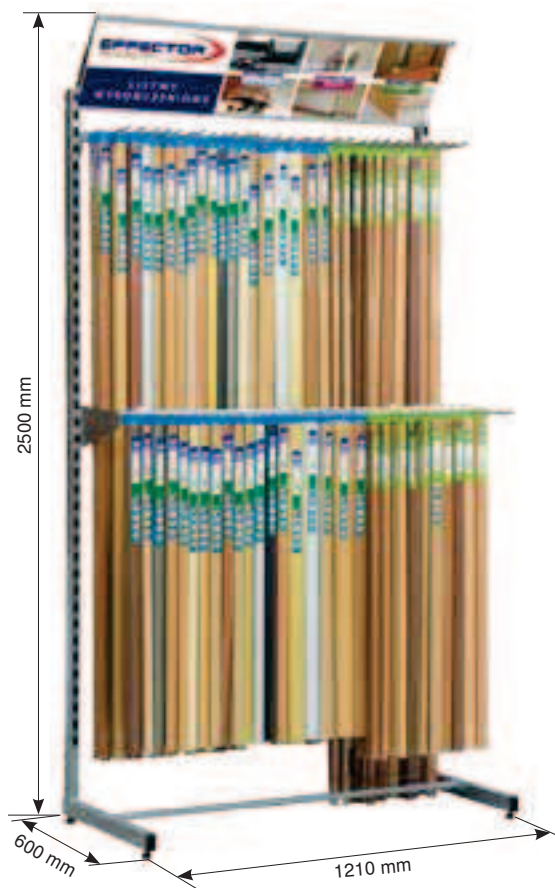

EFFECT 60 + EFFECT 40



WIESZAK/HANGER



EKSPOZYTORY

STANDS | DISPLAYS | ОТОБРАЖАЕТ

EFFECT EASY

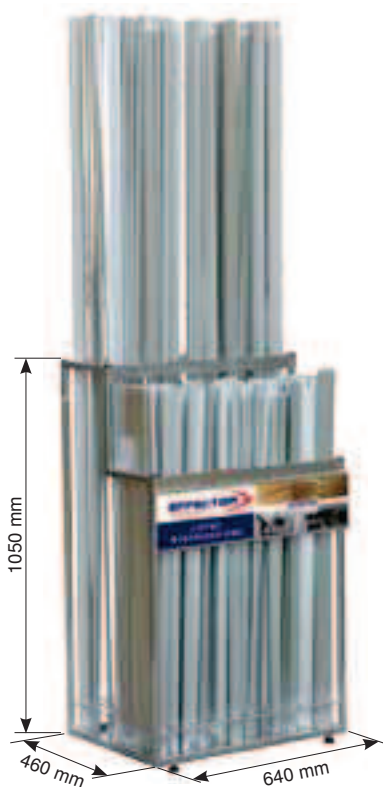

EFFECT EASY BOX

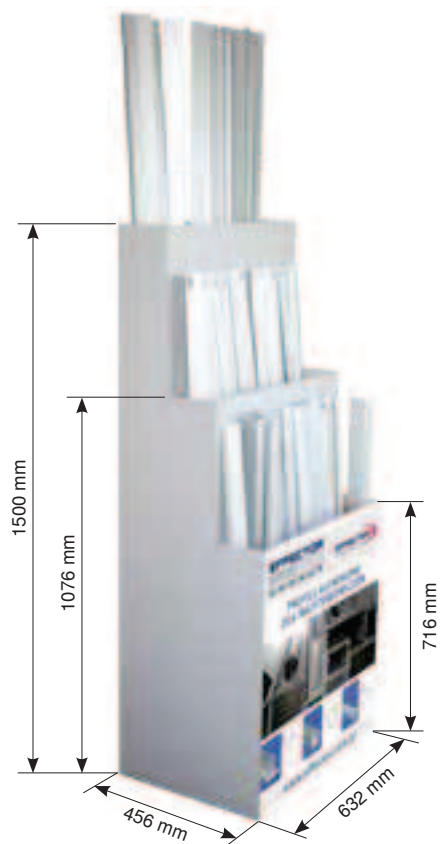

EFFECT QUEEN 10



EFFECT QUEEN 15



EKSPOZYTORY

STANDS | DISPLAYS | ОТОБРАЖАЕТ

EFFECT IMPRESJA

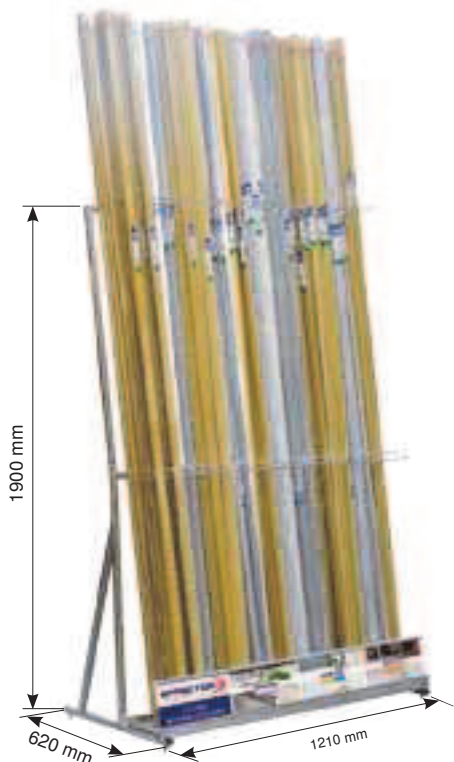

EFFECT IMPRESJA 80

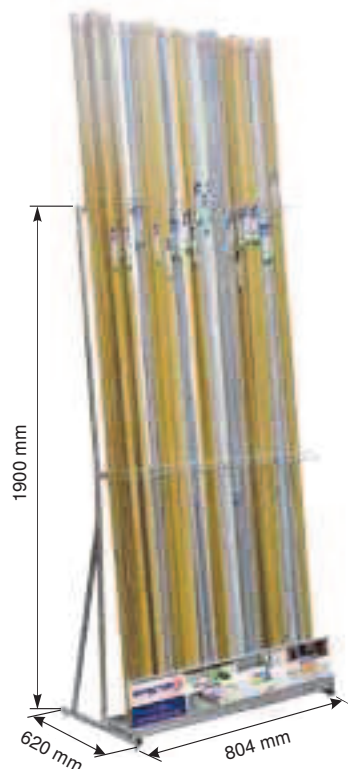

EFFECT RAINBOW

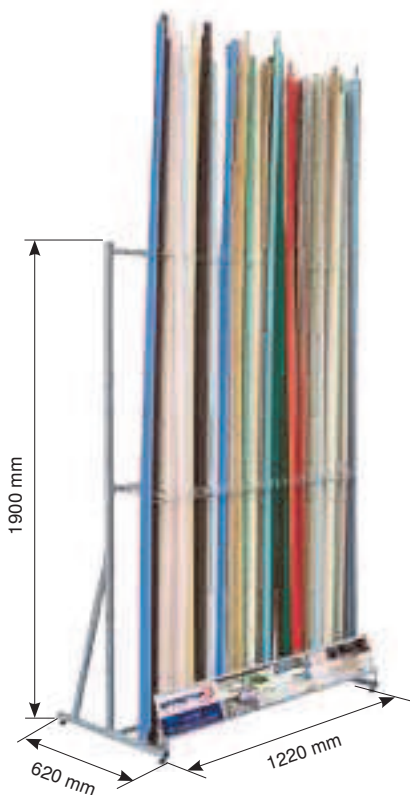

EFFECT RAINBOW DWUSTRONNY





EFFECTOR S.A.

29-100 Włoszczowa, ul. Młynarska 29

tel. +48 41 39 42 799, fax +48 41 39 45 120

e-mail: aludecor@effector.com.pl

Katalog stanowi informację handlową i nie może być uznawany za ofertę w rozumieniu art. 66 ust. 1 Kodeksu Cywilnego. Stanowi on jedynie zaproszenie do rokowań w rozumieniu art. 71 Kodeksu Cywilnego. Ze względu na proces technologiczny druku, kolory przedstawionych produktów mogą różnić się od oryginału.

LISTWY WYKOŃCZENIOWE I ELEMENTY ARANŻACJI WNĘTRZ
FINISHING PROFILES AND ELEMENTS OF INTERIOR DESIGN
LISTWY WYKOŃCZENIOWE I ELEMENTY ARANŻACJI WNĘTRZ
FINISHING PROFILES AND ELEMENTS OF INTERIOR DESIGN LISTWY

www.effector.com.pl